



Scan for full manual

## VSM-4x4X Quick Start Guide

This guide helps you install and use your VSM-4x4X for the first time.

Go to [www.kramerav.com/downloads/VSM-4x4X](http://www.kramerav.com/downloads/VSM-4x4X) to download the latest user manual and check if firmware upgrades are available.

### Step 1: Check what's in the box

- ✓ VSM-4x4X 4K 4x4 Seamless Matrix Switcher/Multi-Scaler
- ✓ 1 Power cord
- ✓ 1 Quick start guide
- ✓ 1 Set of rack ears
- ✓ 4 Rubber feet

### Step 2: Get to know your VSM-4x4X

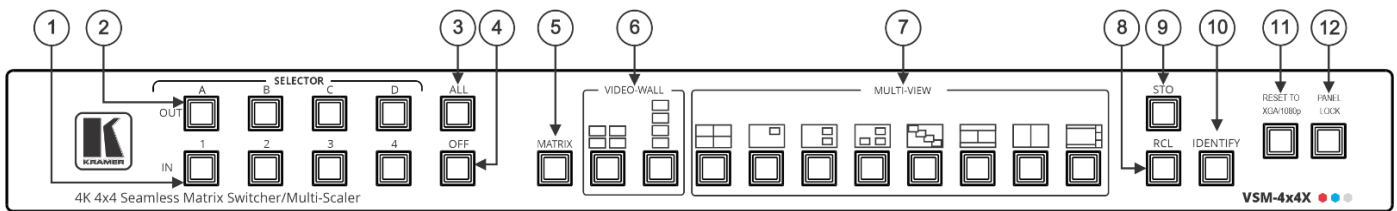

#	Feature	Function
1	IN SELECTOR Buttons	Press to select an HDMI input (from 1 to 4) to switch to an output or a window.
2	OUT SELECTOR Buttons	In the MATRIX mode: select the output to which the input is switched (A, B, C or D). In the VIDEO WALL mode: not used. In the MULTI-VIEW mode: select the input for each window on the display.
3	ALL Button	Press ALL followed by an INPUT button to connect that input to all the outputs (not available for the video wall mode).
4	OFF Button	Press after pressing an output button to disconnect the selected output from the inputs. To disconnect all the outputs, press ALL followed by OFF.
5	MATRIX Mode	Press to operate the system as a matrix switcher.
6	VIDEO-WALL Mode	Press to operate as a video wall.
		2x2  Configure a 2x2 video wall.
		1x4  Configure a 1x4 video wall.
7	MULTI-VIEW Mode	Press to operate in multi-view configurations:
		Quad  4 windows filling the display.
		PiP  1 window over a background image.
		2 windows over a background image.
		3 windows over a background image.
		Stacked  4 images, overlapping (maintaining aspect ratio).
		PoP  2 images, side-by-side (maintaining aspect ratio).
		2 images, displayed as a split-screen (elongated images).
		1 large window and 3 smaller images on the side (maintaining aspect ratio).
8	RCL Button	Press to recall a configuration.
9	STO Button	Press to store a configuration.
10	IDENTIFY Button	Press to indicate which input is displayed on each output or window. The display time is set via the OSD menu.
11	RESET TO XGA/1080p Button	Press and hold for about 5 seconds to toggle resetting the video resolution to XGA or 1080p.
12	PANEL LOCK Button	Press and hold for about 5 seconds to toggle locking the front panel buttons.

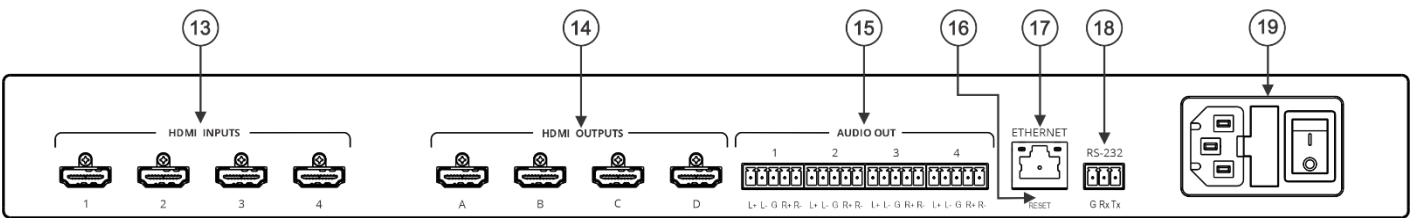

#	Feature	Function
13	HDMI INPUT Connectors	Connect to the HDMI sources (from 1 to 4).
14	HDMI OUTPUT Connectors	Connect to HDMI acceptors (from A to D).
15	AUDIO OUT 5-pin Terminal Block Connector	Connect to a balanced audio source (from 1 to 4).
16	RESET Recessed button	Press and hold while powering on the device to reset to factory default parameters.
17	ETHERNET Connector	Connect to the PC or other Serial Controller through computer networking.
18	RS-232 3-pin Terminal Block Connector	Connect to the PC or a remote controller.
19	Mains Power Connector, Fuse and Switch	Connect to the mains supply and use the switch to turn the unit on or off.

The terms HDMI, HDMI High-Definition Multimedia Interface, and the HDMI Logo are trademarks or registered trademarks of HDMI Licensing Administrator, Inc.

### Step 3: Mount VSM-4x4X

To rack mount the machine, attach both rack ears (by removing the screws from each side of the machine and replacing those screws through the rack ears) or place the machine on a table.

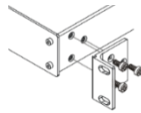

- Ensure that the environment (e.g., maximum ambient temperature & air flow) is compatible for the device.
- Avoid uneven mechanical loading.
- Appropriate consideration of equipment nameplate ratings should be used for avoiding overloading of the circuits.
- Reliable earthing of rack-mounted equipment should be maintained.

### Step 4: Connect inputs and outputs

Always switch OFF the power on each device before connecting it to your VSM-4x4X.

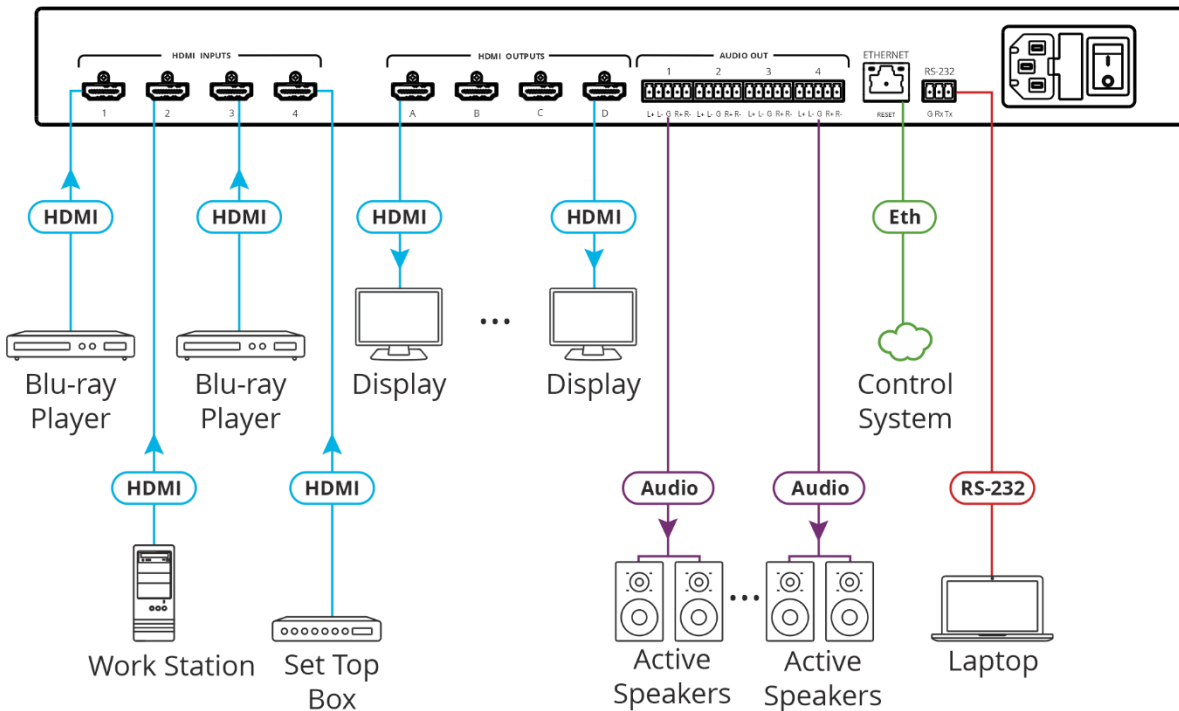

#### Connecting the audio output

To a balanced stereo audio acceptor:

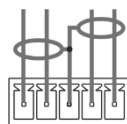

L+ L- G R+ R-

To an unbalanced stereo audio acceptor:

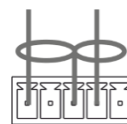

L+ L- G R+

The following are connection examples for different layout configurations, as defined by the front panel buttons and the embedded web pages.

**MATRIX Mode**

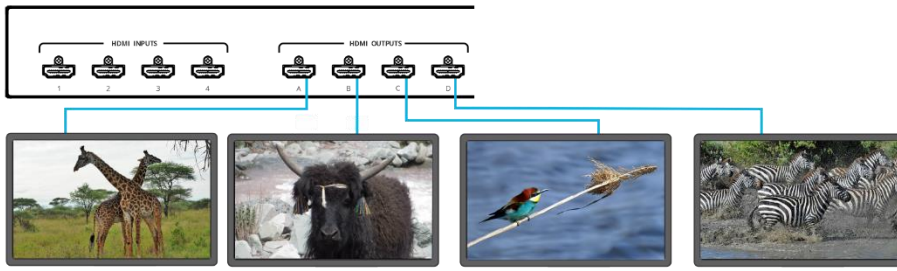

**VIDEO WALL Mode: 1x4**

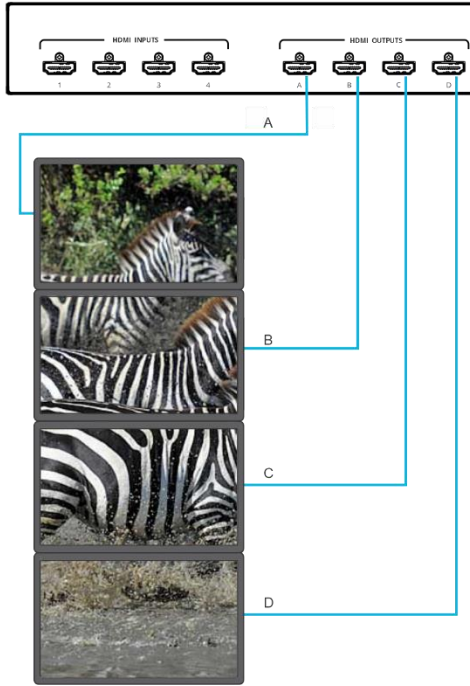

**VIDEO WALL Mode: 2x2**

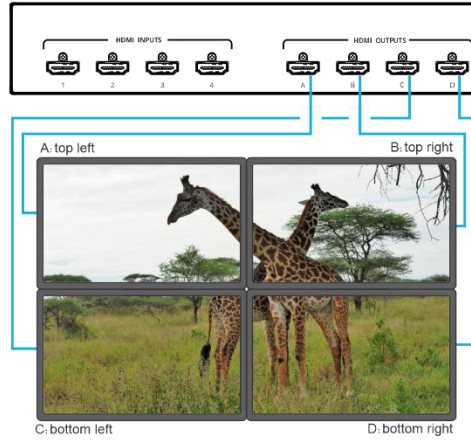

**Multi-View Mode – Split Screen**

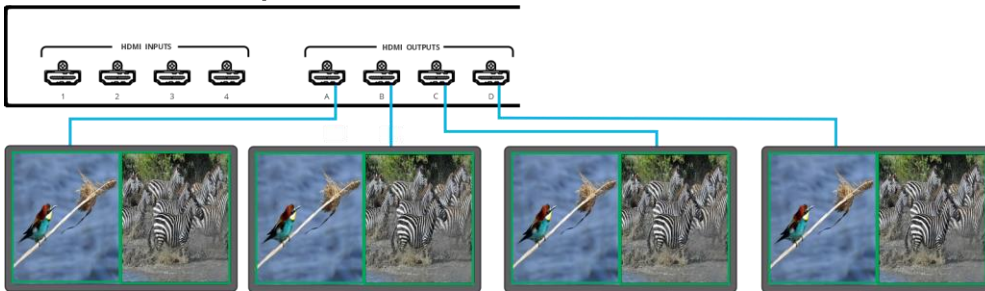

**Multi-View Mode – Side by Side**

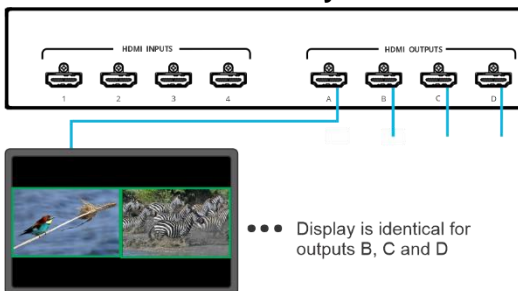

**Multi-View Mode – PiP 2**

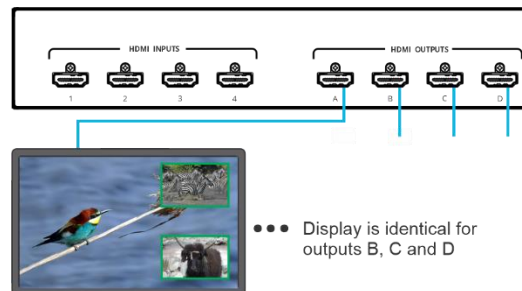

### Multi-View Mode – Stacked

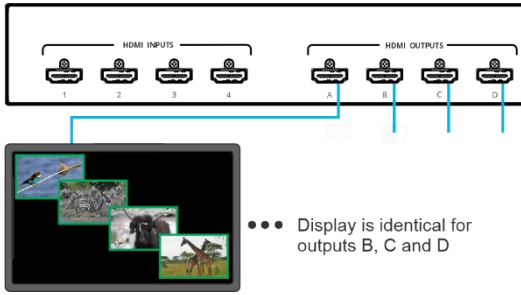

### Multi-View Mode – POP3 (Side)

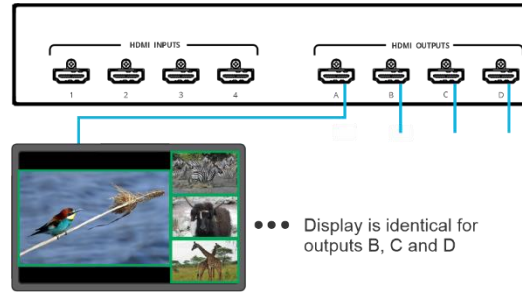

### Multi-View Mode – POP3 (Bottom)

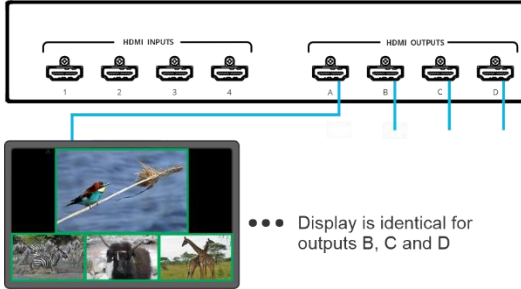

## Step 5: Connect power

Connect the power cord to **VSM-4x4X** and plug it into the mains electricity.

Safety Instructions (See [www.kramerav.com](http://www.kramerav.com) for updated safety information)

**Caution:**

- For products with relay terminals and GPIO ports, please refer to the permitted rating for an external connection, located next to the terminal or in the User Manual.
- There are no operator serviceable parts inside the unit.

**Warning:**

- Use only the power cord that is supplied with the unit.
- Disconnect the power and unplug the unit from the wall before installing.
- Do not open the unit. High voltages can cause electrical shock! Servicing by qualified personnel only.
- To ensure continuous risk protection, replace fuses only according to the rating specified on the product label which located on the bottom of the unit.

## Step 6: Operate VSM-4x4X

Operate **Product** via:

- Front panel buttons
- Remotely, by RS-232 serial commands transmitted by a touch screen system, PC, or other serial controller
- Embedded web pages via the Ethernet

RS-232 Control / Protocol 3000			
Baud Rate:	115,200	Parity:	None
Data Bits:	8	Command Format:	ASCII
Stop Bits:	1		
Example: (Set view mode to POP3 (Side)): #VIEW-MOD 5			
Default Ethernet Parameters			
IP Address:	192.168.1.39	UDP Port #:	50000
Subnet mask:	255.255.0.0	TCP Port #:	5000
Gateway:	192.168.0.1		