



USER MANUAL

MODEL:

VIA Connect²

**Presentation & Collaboration Device
(Firmware Version 4.0)**



Contents

Contents	2
Introduction	3
Getting Started	3
Overview	4
Typical Applications	6
Glossary	6
Supported OS	8
Defining VIA Connect² Presentation & Collaboration Device	9
For Installer: Mounting VIA Connect²	10
For Installer: Connecting VIA Connect²	11
Connecting Device	11
Connecting Main Display	12
For Web Administrator: Gateway Management Pages	13
Logging in to Gateway Management Pages	14
User Management	16
Device Management	18
➤ Network Settings	18
➤ VIA Pad Configuration	22
➤ Site Management	24
➤ VIA Screen Editor	25
➤ VIA Settings	37
➤ Display Controller	55
➤ Calendar – Integrating Third Party Calendars	56
➤ Third Party Apps	58
Digital Signage	59
Reports	68
Utility	69
For Web Administrator: Gateway Dashboard	73
Logging in to the Gateway Dashboard	73
Settings – Logging into the Settings tab	74
Accessing System Controls	79
For User: Connecting via VIA Connect²	81
Installing or Running the VIA app	82
Joining a Room with the VIA app	83
Presenting from the VIA User Dashboard	84
Presenting from a VIA Pad	85
Other Presentation Methods	86
Sharing Media from the User Dashboard	89
Moderating - Controlling the Meeting	95
Collaborating on the Main Display	97
Using the Whiteboard	98
Chatting and File Sharing	100
For User: Advanced Features	101
Using the Gateway Dashboard	101
Listing Default Meeting Spaces in the Mobile App	104
Streaming a Meeting Session	105
Connecting a Video Conferencing Device	109
Technical Specifications	110
VIA App Android Permissions	111

Introduction

Welcome to Kramer Electronics! Since 1981, Kramer Electronics has been providing a world of unique, creative, and affordable solutions to the vast range of problems that confront the video, audio, presentation, and broadcasting professional on a daily basis. In recent years, we have redesigned and upgraded most of our line, making the best even better!

Getting Started

We recommend that you:

- Unpack the equipment carefully and save the original box and packaging materials for possible future shipment.
- Review the contents of this user manual.



Go to [www.kramerav.com/downloads/VIA_Connect²](http://www.kramerav.com/downloads/VIA_Connect2) to check for up-to-date user manuals, application programs, and to check if firmware upgrades are available (where appropriate).

Achieving Best Performance

- Use only good quality connection cables (we recommend Kramer high-performance, high-resolution cables) to avoid interference, deterioration in signal quality due to poor matching, and elevated noise levels (often associated with low quality cables).
- Do not secure the cables in tight bundles or roll the slack into tight coils.
- Avoid interference from neighboring electrical appliances that may adversely influence signal quality.
- Position your Kramer **VIA Connect²** away from moisture, excessive sunlight and dust.

Safety Instructions



Caution:

- This equipment is to be used only inside a building. It may only be connected to other equipment that is installed inside a building.
- For products with relay terminals and GPIO ports, please refer to the permitted rating for an external connection, located next to the terminal or in the User Manual.
- There are no operator serviceable parts inside the unit.



Warning:

- Use only the power cord that is supplied with the unit.
- Disconnect the power and unplug the unit from the wall before installing.
- Do not open the unit. High voltages can cause electrical shock! Servicing by qualified personnel only.
- To ensure continuous risk protection, replace fuses only according to the rating specified on the product label which is located on the bottom of the unit.

Recycling Kramer Products

The Waste Electrical and Electronic Equipment (WEEE) Directive 2002/96/EC aims to reduce the amount of WEEE sent for disposal to landfill or incineration by requiring it to be collected and recycled. To comply with the WEEE Directive, Kramer Electronics has made arrangements with the European Advanced Recycling Network (EARN) and will cover any costs of treatment, recycling and recovery of waste Kramer Electronics branded equipment on arrival at the EARN facility. For details of Kramer's recycling arrangements in your particular country go to our recycling pages at www.kramerav.com/il/quality/environment.

Overview

Congratulations on purchasing your Kramer **VIA Connect² Presentation & Collaboration Device**. **VIA Connect²** has two USB 3.0 port, One USB 2.0, HDMI IN, HDMI OUT, one Ethernet port, one charging port, and one On/Off switch.

VIA Connect² is a smart, secure, wireless, and wired presentation and collaboration platform that makes it easy to have productive meetings and classes. With any laptop or mobile device, users can view, edit, and comment on documents in real time sessions. Participants can display or stream full, uninterrupted video up to 4K@60Hz from their device, and even play YouTube® videos in full frame rate. Up to four participants can share their screens simultaneously on the main display either using the VIA app mirroring feature, iOS mirroring via AirPlay™, Windows & Android mirroring via Miracast™, or ChromeBook mirroring. **VIA Connect²** is optimized for video conferencing and supports Microsoft Teams®, and Zoom®. The platform can handle most small to medium size meeting spaces and is ideal for classrooms and huddle spaces. **VIA Connect²** is super-compact (74x74mm) and flexible to install with both built-in WiFi and LAN connectivity and includes industry-leading 1024-bit encryption for secure use on the internal network.

VIA Connect² provides exceptional quality, advanced user-friendly operation and flexible control.

Key Features

- User friendly, intuitive meeting dashboard requiring few clicks. Easy to join/leave a meeting, select a VIA device, share or stream content, to chat, easy to invite people to join and view connected devices. Helpful tooltips appear when the mouse hovers over a button.
- Multilingual Support – VIA Menus can be displayed in 10 different languages.
- Third party applications - Easy to add and launch third party applications from VIA. Launch MS Teams/Zoom on your device and share it on VIA while using VIA Versa (Room Peripherals).
- Auto Discover and Auto Connect – VIA devices on the LAN are discovered and listed automatically, users can automatically reconnect to the last connected device.
- Auto Disconnect – VIA devices that have left the room can be disconnected by monitoring the strength of their RSSI signal.
- Preview –Moderators can preview presentation content before allowing the presenter to proceed (in Active Directory Moderator Mode).

- VIA VERSA – Use VIA Versa to wirelessly connect to a professional grade camera and AV in the meeting space.
- Comprehensive Collaboration Functionality – Whiteboard, Filesharing, Application sharing, Chat, etc.
- View Main Display (VMD) – Meeting participants can view the main display on their personal device and use the VMD feature to make annotations locally or publicly.
- Simultaneous Display – Four participants can simultaneously present content on the main display.
- Present Privately (do not disturb) Feature – Allows the presenter to continue the presentation without being interrupted.
- Pause/Resume Presentation – Present at your convenience.
- Calendar Wallpaper and Meeting Connection – Connect the VIA to a supported calendar and list upcoming meetings on the Main Display. Connect to the meeting by clicking on the calendar entry in the display.
- Digital Signage – Display dynamic content and information on the main display when VIA is not being used for a meeting. Use a predefined template or create your own display configuration with up to three frames of content that appear simultaneously. Schedule campaigns (content configurations) to run automatically at specific dates and times.
- Seamless Live Video Streaming – Stream live content from meeting rooms, classrooms and studios using RTSP/RTP to all the leading platforms, like YouTube™, Kaltura™, Panopto™ and more.
- Powerful Security Features – 802.1x User authentication, 1024-bit encryption, dynamic room codes.
- Cloud-Based Management – Use VIA Site Management (VSM) cloud-based web application, to manage and configure large numbers of VIA devices from anywhere.
- Quick and Reliable Wireless Connectivity – An intuitive user interface enables iOS™, Android™, Chromebook™, PC, and Mac™ device users to instantly connect to a main display either using VIA Pad or Bluetooth without relying on the organizations' Guest network. 2.4GHz/5GHz WiFi and MIMO antennas establish and maintain a fast and reliable connection.
- Up to 4K@60 HDMI™ Wired Input – Enables hard-wiring, auto switching, for connecting a computer or any HDMI compatible device camera, multimedia player or computer that supports HDCP signals.
- High-Quality Video Streaming – Supports up to 4K@60Hz resolution using the VIA app Multimedia feature.
- Clientless Connectivity – Airplay, Miracast, Join Through Browser.
- Built-In WiFi, Bluetooth and LAN. Seamless switching between wireless networking and LAN.
- Wireless USB – Supports Microphone, Speaker & Camera.
- Easy and Flexible Installation – VIA's super-compact form factor allows it to be discreetly installed on the back of a display, projector or almost anywhere.

Typical Applications

VIA Connect² is ideal for the following typical applications:

- Presentation environments.
- Small to mid-size meeting rooms.
- Classrooms.

Glossary

The following are definitions of some common terms found in this User Manual.



Screenshots in this section are representative only and may not accurately reflect the features associated with your VIA device.

- **VIA Meeting** – A session where one or more users are logged into your VIA unit using the Kramer VIA app.
- **Gateway** – A VIA device such as VIA Connect².
- **Main Display** – The monitor connected to the VIA Connect² HDMI output. The screen used for presentation and collaboration.
- **VIA App User Dashboard** – Main interface for meeting participants using the VIA app. See [Presenting from the VIA User Dashboard](#) on page 84.

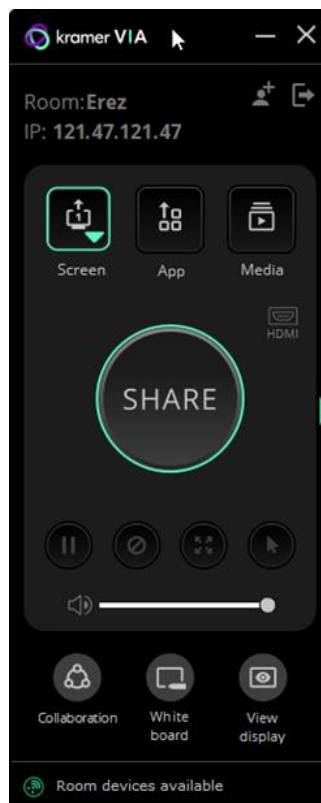

Figure 1: VIA Dashboard

- **VIA Gateway Dashboard** – VIA Connect² device interface used from the main display by a keyboard and mouse connected to the VIA Connect² (or by using Collaboration mode). Click the VIA icon in the lower left corner of the Main Display to open this interface.

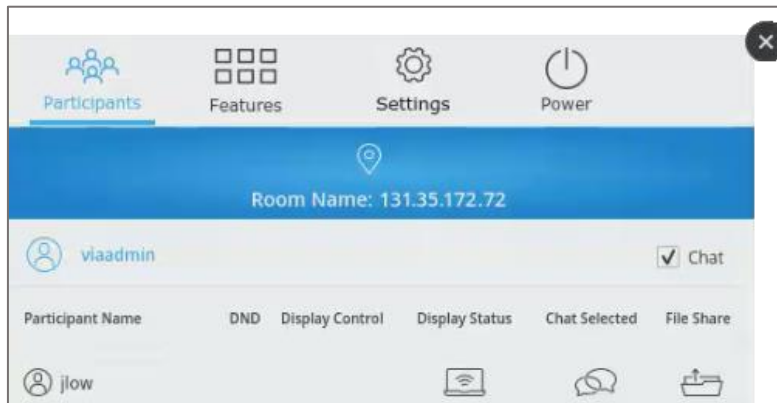

Figure 2: Gateway Dashboard

- **Gateway Management Web Pages** – Web pages embedded in your VIA Connect² gateway that enables you to configure this gateway. The Gateway Management Web Pages are accessed from any computer connected to the same network as the gateway.

Supported OS

The following user devices are supported by the **VIA Connect² Presentation & Collaboration Device**:

- Windows 8/10[®] (32-bit/64-bit) computer.
- Macintosh[®] computer, using OSX 10.12.x or newer.
- Chromebook.
- iPad/iPhone[®] tablet/smartphone (iPad 2 or later, iOS 12 or later).



When using the Airplay service, no Kramer VIA application is needed. However, we recommend using iOS12, Mojave OS X, or higher, for a better experience.

- Android[®] OS 5. x tablet/smartphone or newer.



The minimum system requirement for using the **Kramer VIA** mirroring feature for an Android device is Android 5.1.

Defining VIA Connect²

Presentation & Collaboration Device

This section defines VIA Connect².

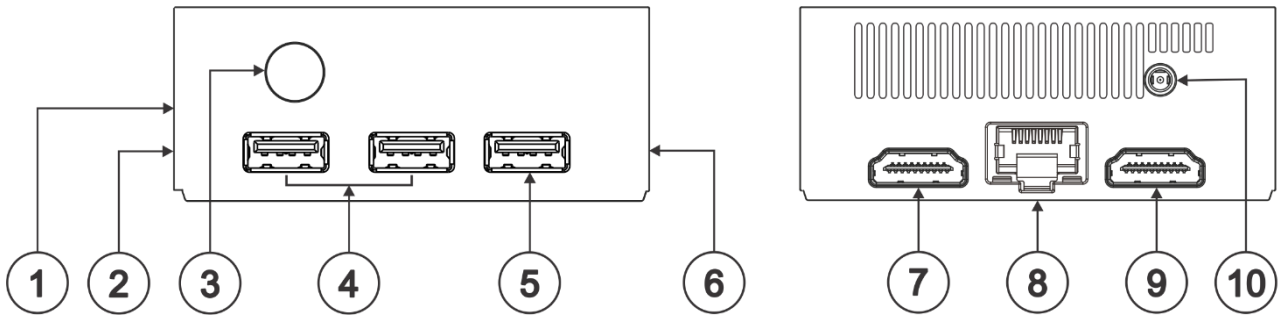

Figure 3: VIA Connect² Front Panel

#	Feature	Function
①	Video Toggle Connector	Connect to video toggle cable for toggling between VIA input and HDMI™ input.
②	Micro SD Card Slot	Not in use.
③	Power Button with LED	Press to power ON or turn OFF the device.
④	USB 3.0 Connectors (x2)	Connect to USB devices, for example, a keyboard and a mouse.
⑤	USB 2.0 Connector	Connect to a USB device, for example, a keyboard or mouse.
⑥	Lock Opening	Connect to a security locking cable.
⑦	HDMI™ OUT Connector	Connect to an HDMI sink.
⑧	RJ-45 Connector	Connect to a LAN (default mode).
⑨	HDMI™ IN Connector	Connect to an HDMI source.
⑩	Power Connector	Connect to the 12V DC power supply.

For Installer: Mounting VIA Connect²

This section provides instructions for mounting **VIA Connect²**. Before installing, verify that the environment is within the recommended range:



- Operation temperature – 0° to 40°C (32 to 104°F).
- Storage temperature – -40° to +70°C (-40 to +158°F).
- Humidity – 10% to 90%, RHL non-condensing.



Caution:

- Mount **VIA Connect²** before connecting any cables or power.
- The device is intended to be installed at a height of 2 meters or less.



Warning:

- Ensure that the environment (e.g., maximum ambient temperature & air flow) is compatible for the device.
- Avoid uneven mechanical loading.
- Appropriate consideration of equipment nameplate ratings should be used for avoiding overloading of the circuits.
- Reliable earthing of rack-mounted equipment should be maintained.

You can install VIA Connect² using one of the following methods:

- Place the device on a flat surface.
- Mount on a wall or the back of a display using the included VESA mounting bracket:

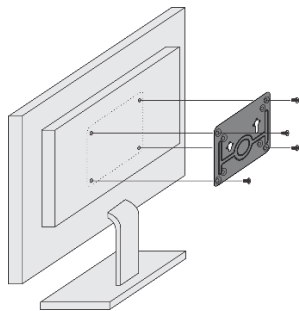

1. Attach the VESA mounting bracket to the back of the display with 4 screws.

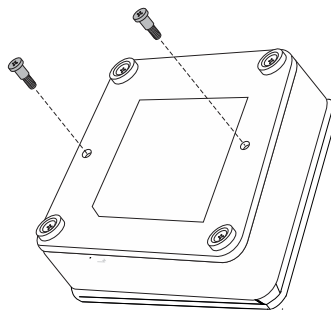

2. Fasten two screws to the bottom of **VIA Connect²**.

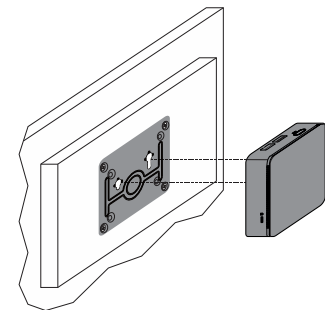

3. Insert the screws on the bottom of **VIA Connect²** into the slots on the mounting bracket.



When mounting the device on a display, the installer **MUST** secure the display to prevent instability.

For Installer: Connecting VIA Connect²



Always switch off the power to each device before connecting it to your **VIA Connect²**. After connecting your **VIA Connect²**, connect its power and then switch on the power to each device.

Connecting Device

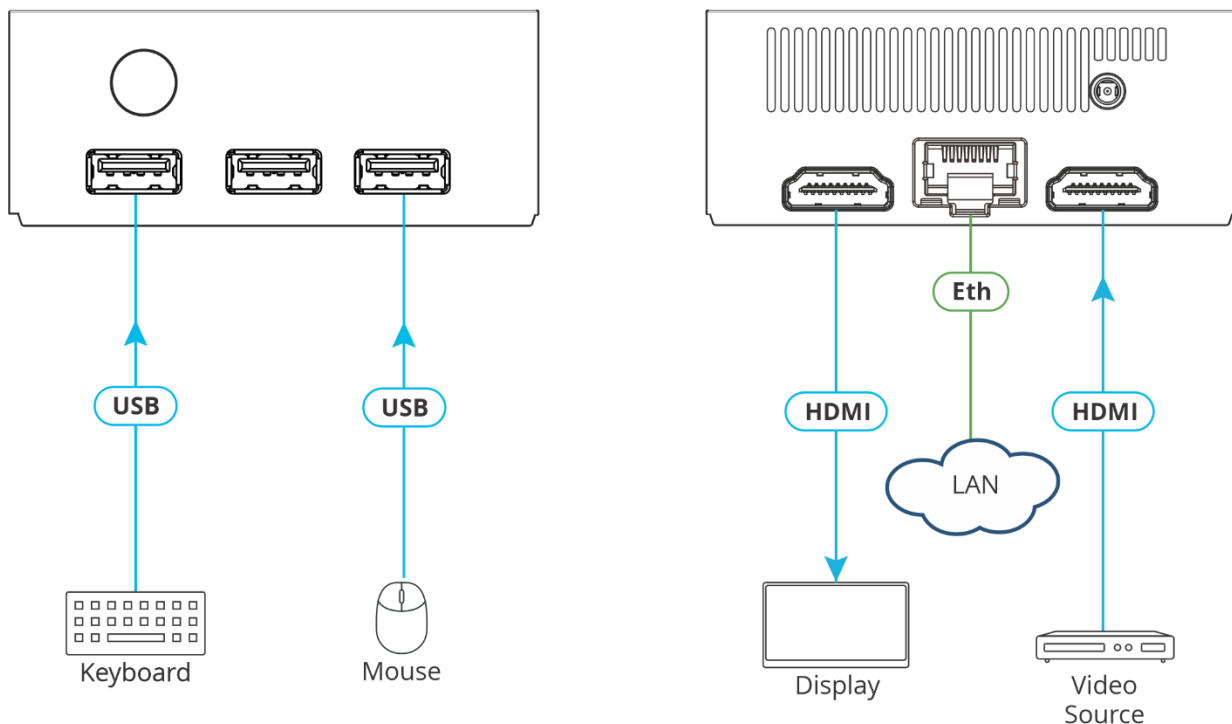

Figure 4: Connecting VIA Connect²

To connect VIA Connect² as illustrated in [Figure 4](#):

1. Connect the keyboard and mouse.
2. Connect an HDMI display.
3. Connect to the LAN (default mode).
4. If required, connect a wired HDMI video source.



If you wish to use a Kramer active optical pluggable HDMI cable with your **VIA Connect²**, contact your local Kramer office to assist in purchasing the correct cable.

Connecting Main Display

The main display is the screen connected directly to **VIA Connect²**. When **VIA Connect²** is booted up, the VIA gateway screen appears on the main display. All collaboration activity is then displayed here.

VIA Connect² enables connecting the following display type:

- HDMI – The HDMI OUT Connector (5) connects to any compatible projection or direct-view display, such as an LCD monitor. This connection can be routed and switched.

VIA Connect²'s internal video card reads the EDID (Extended Display Identification Data) for any connected display and sets the optimum display resolution and image refresh rate automatically through the display connectors.

For Web Administrator: Gateway Management Pages

VIA Connect² administration is divided into two groups of settings:

- **Gateway Management Pages** – Controls general device settings (see the list below). These high-level controls can only be accessed over LAN, with an administrator's password.
- **Gateway Dashboard** - Controls the User Dashboard interface presented to meeting participants. Only accessible with a mouse and keyboard connected to the VIA Connect². Limitations can be set by the Management Pages and, depending on how the device is setup, it may be possible for non-administrators to change some of the settings (see [For Web Administrator: Gateway Dashboard](#) on page 73).

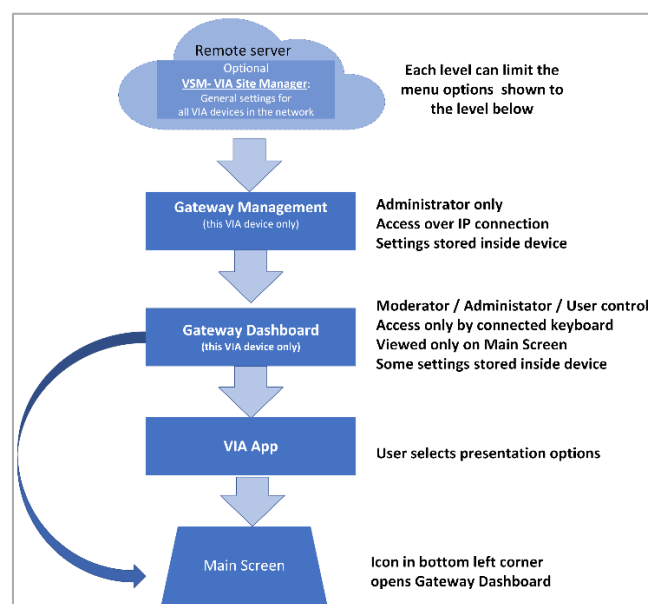

Figure 5: VIA Connect² hierarchy of control

Gateway Management Pages manage general VIA Connect² settings including:

- [Logging in to Gateway Management Pages](#) on page 14.
- [User Management](#) on page 16.
- [Device Management](#) on page 18.
- [VIA Pad Configuration](#) on page 22.
- [Site Management](#) on page 24.
- [VIA Screen Editor](#) on page 25.
- [VIA Settings](#) on page 37.
- [Display Controller](#) on page 55.
- [Calendar – Integrating Third Party Calendars](#) on page 56.
- [Digital Signage](#) on page 59.

- [Reports](#) on page [68](#).

Logging in to Gateway Management Pages

The Gateway Management Pages enable you to configure your **VIA Connect²** gateway device. The Gateway Management Pages are accessed from any computer connected to the same network as your gateway.

To log in to the VIA Connect² Gateway Management Pages:

1. Connect your computer to the same network to which **VIA Connect²** is connected.
2. Open a Web browser and go to the IP address for your **VIA Connect²** unit.
The VIA Collaboration Hub page appears.

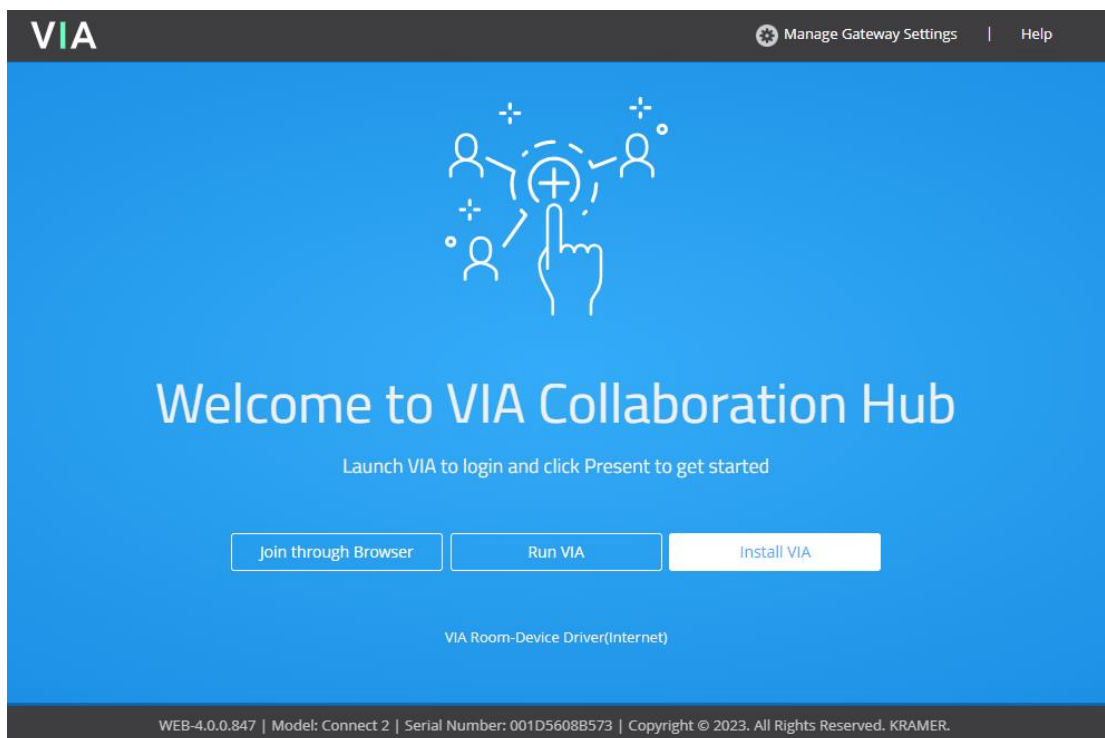

Figure 6: VIA Collaboration Hub

3. Click **Manage Gateway Settings** in the upper right corner.
The Administrator Login page appears.
4. Type a Web Administrator Username (default = su) and Password (default = supass).

Figure 7: Administrator Login Page



To access settings through the Gateway Management Pages, you must log in as a Web Administrator (see [User Management](#) on page 16).

5. If necessary, type the Captcha Text strings with a space between them in the text box.



To disable the Captcha see [Security](#) on page 51.

6. Click **Login**.

The Gateway Management Pages appear with the **Dashboard overview** open.

The screenshot shows the VIA Gateway Management Dashboard for Model: Connect 2. The interface includes a sidebar with navigation options: DASHBOARD, USER MANAGEMENT, DEVICE MANAGEMENT, DIGITAL SIGNAGE, REPORTS, and UTILITY. The main content area displays the following sections:



- System Status:**
 - Hardware Model: N4120
 - Firmware Version: 4.0.0.1293 (with a 'Check For Update' button)
 - Date / Time: 2023-01-03 | 10:59:06
 - System Uptime: 220h 21m
 - Available Space: 10.2 GB (out of 25.5 GB Disk Space)
- Services:**
 - AirPlay: AirPlay Name: 113 (Status: Success)
 - Join through Browser: Connection Status: Success
 - Miracast: (Status: Disabled)
 - VIA Broadcast: Room Name: Kaza (Status: Success)
- Audio (Change audio setting):**
 - Audio Input: No device found
 - Audio Output: HDMI
- LAN:**
 - Mac Address: 00:1D:56:08:B5:73
 - Host Name: ehud
 - Gateway IP: 192.168.30.16
 - Subnet Mask: 255.255.0.0
 - Default Gateway: 192.168.0.254
 - DNS Server: 172.12.0.4, 172.12.0.6
- WiFi:**
 - Mac Address: 14:5A:FC:78:8B:9F
 - Mode: AP
 - SSID: VIA_Kaza
 - Channels: 36
 - Internet Access: Enabled
 - Standalone Wifi: Disabled
 - Guest Mode: Disabled
- Site Management:**
 - VSM Server: kramer.cloudvsm.com (Connection Status: Success)
 - License Status: License assigned (Connection Status: Success)
 - Discovery Server: (Connection Status: Success)

At the bottom left, there are buttons for 'Reboot' and 'Shutdown'. The footer contains the text: WEB-4.0.0.847 | Model: Connect 2 | Serial Number: 001D5608 | Copyright © 2023. All Rights Reserved. KRAMER.

Figure 8: The Gateway Management Dashboard

7. The **Gateway Dashboard** provides a grand overview of the system:

- **System Status** (the top data row) – Shows hardware and software status (can be used to update the firmware).
- **Services** – Shows the live connection status.
- **LAN** – Shows an overview of the network settings.
- **WiFi** – Shows an overview of the WiFi settings.
- **Audio** – Shows the Connect2 audio output device (can be used to update it).
- **Site Management** – If VSM (VIA Server Management) is active and controlling device settings, its details will be displayed in this section.

-  Click the tabs in the navigation pane on the left to display the VIA web pages.
-  Click the arrow in the upper right corner to select a different language for web pages.

User Management

This section describes how to add user accounts to the database of your **VIA Connect²** device. A user account is required to access the Gateway Management Pages (see [Logging in to Gateway Management Pages](#) on page 14) and, when your **VIA Connect²** is in Database mode (see [Moderator Mode](#) on page 47), a user account is required to join a VIA meeting.

To add a user account to your VIA Connect² database:

1. Click **User Management** on the Gateway Management Pages navigation pane. The User List page appears.

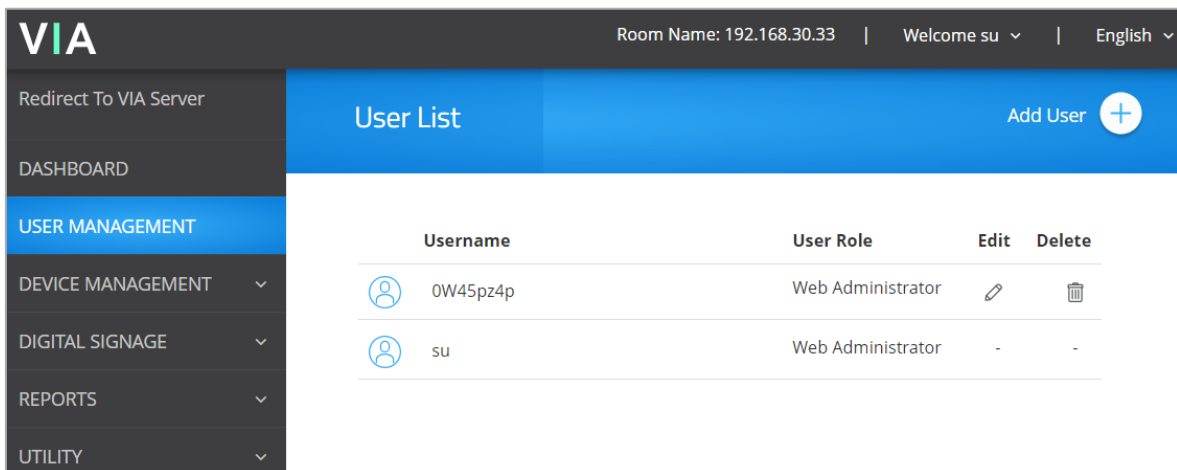

Figure 9: User Management Page

2. Click **Add User**.

The Add User pane appears.

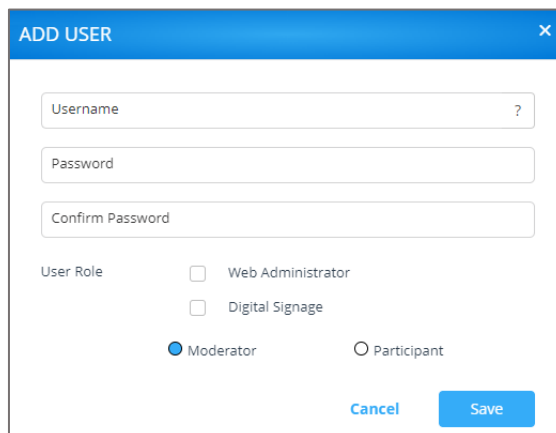



Figure 10: Add User Pane

3. Type the new Username, Password and Confirm Password.
4. Under User Role, select from the following administrative levels:

- **Web Administrator** – Access to change all system settings, including Digital Signage.
 - **Digital Signage** – Able to configure the Digital Signage only (see [Digital Signage](#) on page [59](#)).
5. Select one of the following participation levels:
-  These options are enabled only when Moderator Mode is enabled (see [Moderator Mode](#) on page [47](#)).
- **Moderator** – User can moderate and has access to moderator features.
 - **Participant** – User can join a meeting as a participant but cannot moderate.
6. Click **Save**.
- A new user is added, and the User List tab appears with the new user added to the list.

Device Management

➤ Network Settings

Use the Network settings to change or view:

- [LAN Settings](#) on page [18](#).
- [WiFi Activation](#) on page [19](#).
- [WiFi with AP Mode](#) on page [19](#).
- [WiFi with Client Mode](#) on page [20](#).
- [Connecting VIA Connect² to an 802.1X Network](#) on page [21](#).

LAN Settings

 By default, the IP address of your **VIA Connect²** is set automatically by DHCP. See below if you want to set a static IP address.

 When changing these settings, please contact your IT administrator. Incorrect values can cause a loss of communication.

To change the IP address of your **VIA Connect²** unit:

1. Click **Device Management > Network Settings**.
The LAN setting tab opens with network setting page.
2. Under Connection Type, select **Static**.
3. Under Network Information, rename the Gateway IP.
4. Click **Apply**; The IP address of your **VIA Connect²** unit is changed.

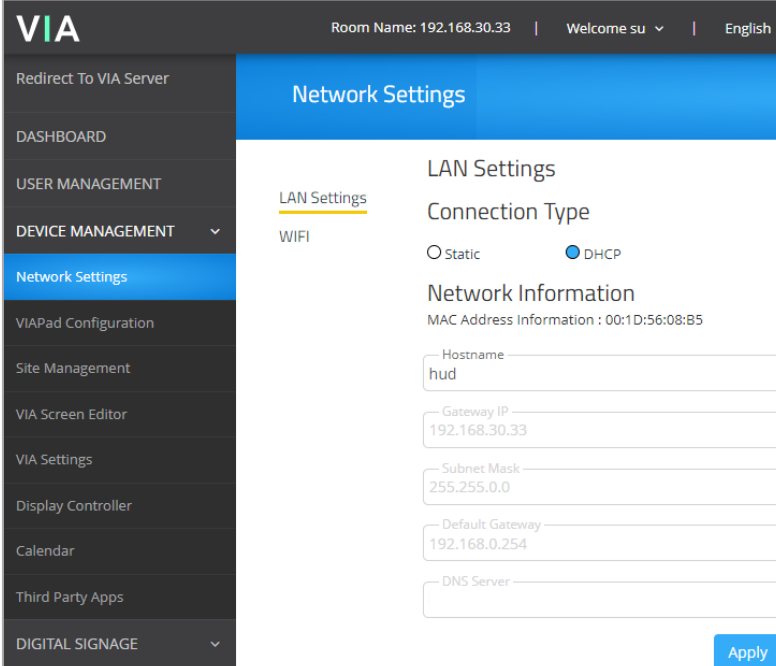

The screenshot displays the VIA web interface for Network Settings. The top navigation bar includes the VIA logo, Room Name: 192.168.30.33, Welcome su, and English. The left sidebar lists various management options, with Network Settings highlighted. The main content area shows the LAN Settings page, where the Connection Type is set to DHCP. The Network Information section contains several input fields: Hostname (hud), Gateway IP (192.168.30.33), Subnet Mask (255.255.0.0), Default Gateway (192.168.0.254), and DNS Server. An Apply button is located at the bottom right of the settings area.

Figure 11: LAN Settings Page

WiFi Activation

VIA Connect² can be setup to use WiFi in two modes: **AP** or **Client**.

- **AP (access point) mode** – Use this option if your device is connected to a LAN. Your VIA Connect² can setup its own WiFi network which can be used by guests to connect to meetings without giving access to the wider network or requiring them to have a network login.
- **Client mode** – Use this option to connect your device to a local network without using a LAN connection.
- **These settings can also be activated locally in the Gateway Dashboard.**

To connect to WiFi:

1. Click **Device Management > Network Settings**; The Network Settings page appears.
2. Click **WiFi**; The WiFi tab appears.

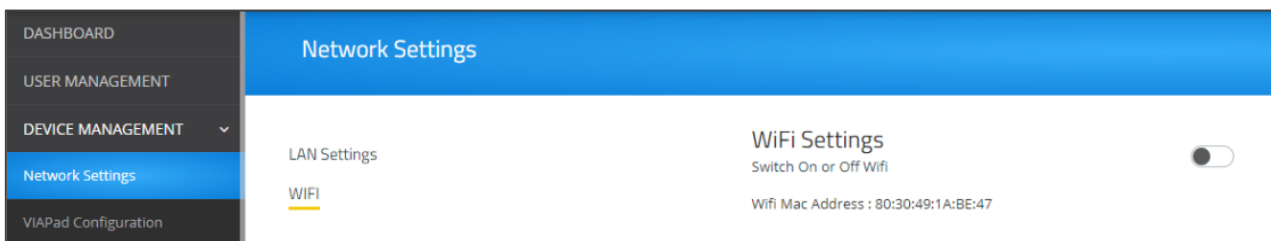



Figure 12: WiFi Setting Tab

3. Click the **Switch On or Off WiFi** switch.

The switch turns green and the WiFi settings appear.

WiFi with AP Mode

VIA Connect² can set up a secure access point for users of your VIA Connect² network. This setup is ideal for guest users who you may not want to connect directly to your network.

 In Moderator Mode (see [Moderator Mode](#) on page 47), only the moderator can enable the Access Point.

Setting up secure wireless guest access point:

1. Click **AP Mode** and enter a new name in the SSID field and a new password. This allows guests to join meetings without needing to login to the corporate/institutional network.
2. Select **Enable Internet** if your VIA Connect² device is connected to a network with internet.

-OR-

Select **Activate Standalone Wifi** to create an autonomous network without Internet access.

3. Select **AP Isolation** to prevent Wi-Fi users from connecting to other through the router. Each user gets a private connection that protects them from harm by malicious users.
4. Click **Apply**; The secure wireless guest access point is set up.

Figure 13: AP Mode Setting Page

WiFi with Client Mode

VIA Connect² enables you to wirelessly connect your VIA Connect² device as a client device to your main network. Use this option if you have no LAN connection available.

To set up Client WiFi mode:

1. Click **Device Management > Network Settings**.

The Network Settings page appears.

2. Click **WiFi**: The WiFi tab appears.

3. Click the **Switch On or Off Wifi** switch: The switch turns green and the WiFi settings appear.

4. Click Client Mode.

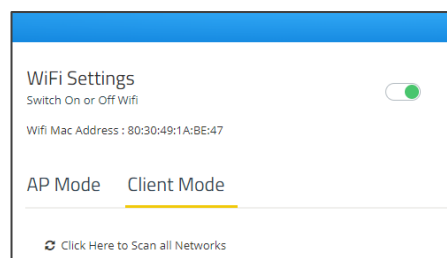

Figure 14: Client Mode Tab

2. If you do not see the desired network, click **Click Here to Scan all Networks**.

3. Select a network.

4. Enter the network password and click **Apply**.

5. Disconnect the LAN cable (if connected) and reboot the device.

Client WiFi Mode is set up.

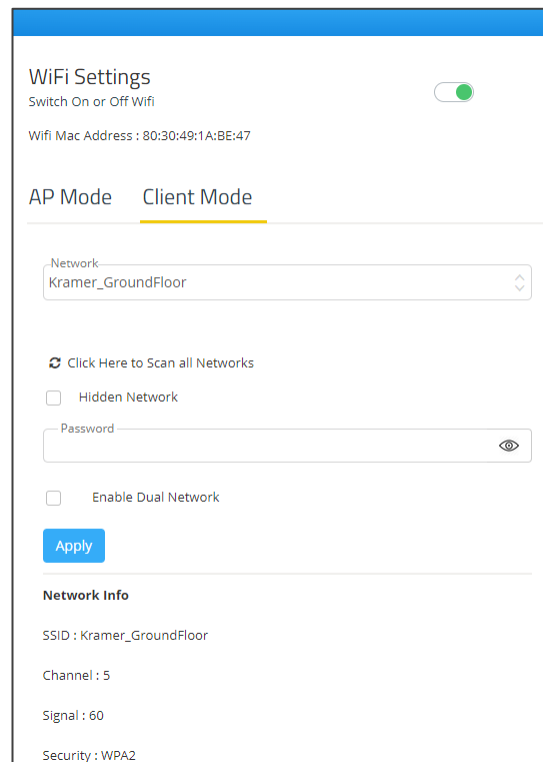

Figure 15: Client Mode Setting Page

Connecting VIA Connect² to an 802.1X Network

VIA Connect² enables you to wirelessly connect your VIA Connect² device as a client device to an 802.1X network using password authentication or EAP-TLS authentication.

EAP-TLS features include:

- Mutual authentication (server to the client and client to server).
- Key exchange to establish dynamic WEP or TKIP keys.
- Fragmentation and reassembly of very long EAP messages, if needed.
- Fast reconnect via TLS session resumption.

To Connect VIA Connect² as a client device to an 802.1X network:

1. Set up a Radius server to validate the certificate that you will upload to VIA Connect².
2. Set up an access point (AP) with 802.1X type security.



The Radius server IP address and password will be passed while configuring the 802.1x security type on the access point. This password is the same one that is used in the Radius server.

3. Click **Device Management > Network Settings** in the navigation pane.

The Network Settings page appears.

4. Click **WiFi**; The WiFi tab appears.
5. Click the **Switch On or Off Wifi** switch; The switch turns green and the WiFi settings appear.
4. Click **Client Mode**; The Client Mode tab appears.



If you do not see the desired network in the dropdown, click **Click Here to Scan all Networks**.

5. Do one of the following:

- To connect to the network with username and password authentication, select the SSID of the access point that is secured by 802.1X.

Your unit can now connect to the network with a username and password.

-OR-

- To connect to the network with EAP-TLS authentication:
 - a. Select the 802.1X (TLS Certificate) checkbox.

Additional settings appear.

- b. Enter the Identity.
- c. Upload the Authority CA, User Certificate and Key files and click **Apply**.

VIA Connect² automatically reboots and is now connected to the 802.1X network.

➤ VIA Pad Configuration

VIA Pad is an optional touch-pad accessory that enables meeting participants to instantly join a VIA meeting with their Mac or PC laptop. **VIA Pad** must be paired with your **VIA Connect²** device before it is used to join meetings. The pairing procedure includes:

- [Configuring VIA Pad Settings](#) on page [22](#).
- [Pairing a VIA Pad Device](#) on page [23](#).

Configuring VIA Pad Settings

VIA Connect² enables you to configure **VIA Pad** settings that define how a **VIA Pad** device operates when paired with your **VIA Connect²** unit.

To configure **VIA Pad** settings:

1. Click **Device Management > VIAPad Configuration** on the navigation pane. The VIAPad Configuration page appears.

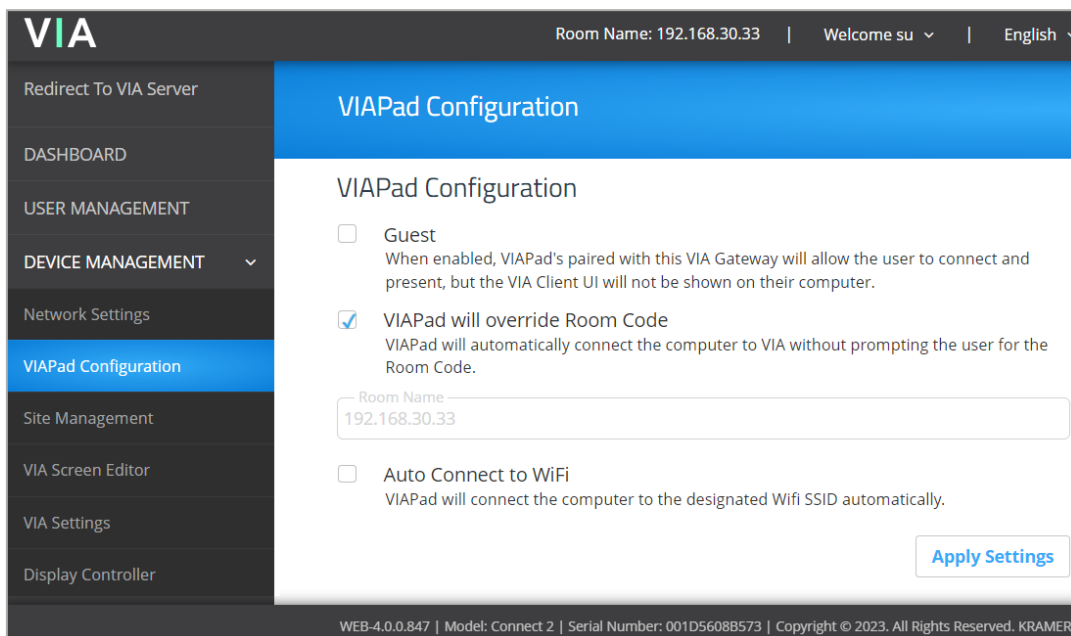

Figure 16: VIA Pad Configuration Page

2. Select the following as required:
 - **Guest** – Participant can Present by touching the VIA Pad device; the **Kramer VIA** User Dashboard is not available.
 - **VIA Pad overrides Room Code** – Participant can join a meeting without entering the room code.



Room Name is automatically populated; it reflects the name of your **VIA Connect²** unit.

3. Select the **Auto Connect to WiFi** checkbox, to configure **VIA Pad** to automatically connect to the meeting space WiFi network: The Auto Connect settings appear.

The screenshot shows the 'VIAPad Configuration' web interface. It features a blue header with the title 'VIAPad Configuration'. Below the header, there are several configuration options:

- Guest: When enabled, VIAPad's paired with this VIA Gateway will allow the user to connect and present, but the VIA Client UI will not be shown on their computer.
- VIAPad will override Room Code: VIAPad will automatically connect the computer to VIA without prompting the user for the Room Code.
- Room Name: 192.168.100.124
- Auto Connect to WiFi: VIAPad will connect the computer to the designated Wifi SSID automatically.
- SSID: [Text input field]
- Authentication Mode: Select [Dropdown menu]
- Encryption: Select [Dropdown menu]
- Key: [Text input field with eye icon]

At the bottom right, there is an 'Apply Settings' button.

Figure 17: VIA Pad Auto Connect Setting Page

4. Define the following for the meeting space WiFi network:

- a. SSID – Name of the network

 Make sure that you write it EXACTLY as defined. This parameter is case sensitive.

- b. Authentication Mode – Security used by your WiFi access point. Select from the pre-set options: **WEP Open**, **WEP Shared**, **WPA Personal**, **WPA2 Personal**.

- c. Encryption – Type of encryption key used by your router.

- d. Key – Password required to join your network (up to 50 characters max).

5. Click Apply Settings: VIA Pad settings are configured.

 After clicking Apply Settings, the configuration is saved, a reboot is not needed.

Pairing a VIA Pad Device

Each **VIA Pad** device must be paired to your **VIA Connect²** unit before being used by a meeting participant. To pair a VIA Pad device to your **VIA Connect²** unit, follow the directions:

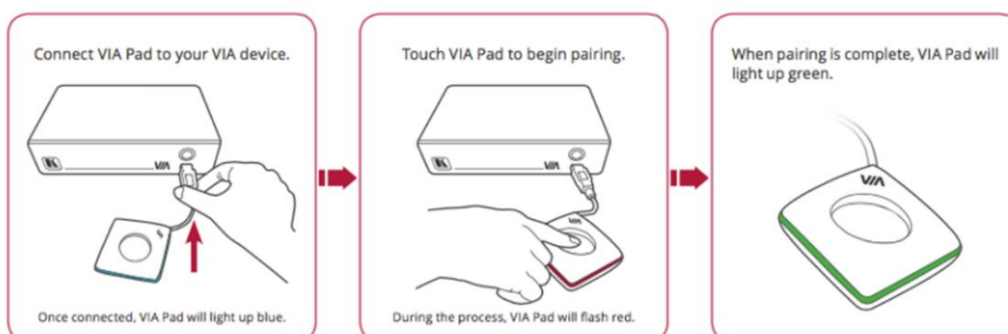

➤ Site Management

VSM (VIA Site Management) is an optional, web-based software application (purchased separately) that enables an administrator to monitor and update all VIA gateways connected to a network. **VIA Connect²** enables you to activate VSM management for a VIA gateway and define which gateway functions are managed by VSM.



Contact your regional sales representative for more details about this solution.



If VIA discovery is enabled and configured in VSM, your VIA device is automatically added under VSM supervision.

To configure VIA Connect² to be managed by VSM when VIA discovery is not activated:

1. Click **Device Management > Site Management** on the navigation pane.

The VIA Site Management page appears.

Function	VSM	Gateway
VIA Screen Editor	<input type="radio"/>	<input checked="" type="radio"/>
VIA Settings	<input type="radio"/>	<input checked="" type="radio"/>
Digital Signage	<input type="radio"/>	<input checked="" type="radio"/>
Calendar Settings	<input type="radio"/>	<input checked="" type="radio"/>

Figure 18: VIA Site Management Page

2. Under the Step 1: Server Settings section, enter the VSM Server IP and the Gateway ID that was defined in VSM for this gateway.
3. Click **Validate and Save**.
Changes take effect immediately.



VIA Connect² must be able to connect to VSM while validating is in progress.

-OR-

Click **Save** for changes to be saved with no validation from VSM.



Since validation is not made immediately, any error entered at this stage, like duplication of ID, must be corrected manually at a later stage.

4. Under the Step 2: Configuration section, in the VSM column, select all functions that you want to be managed by VSM.



After clicking Apply and Reset, changes take 30 minutes to 1 hour to take effect, to allow time to communicate with VSM.

➤ VIA Screen Editor

VIA Connect² enables you to customize the look and feel of the main display home screen:

- [Creating New Screen Layout](#) on page [25](#).
- [Formatting Screen Layout Widgets](#) on page [27](#).
- [Editing a Screen Layout](#) on page [35](#).
- [Deleting a Screen Layout](#) on page [35](#).
- [Exporting and Importing a Screen Layout](#) on page [35](#).

Creating New Screen Layout

VIA Connect² enables you to custom design the screen layout for the main display. You can incorporate your company branding, as well as display custom text, date & time, and meeting login information. Create and save several versions of the screen layout and load them as needed.

To create a new screen layout for the main display:

1. Click **Device Management > VIA Screen Editor** on the Gateway Management Pages navigation pane.
The Screen Editor page appears.

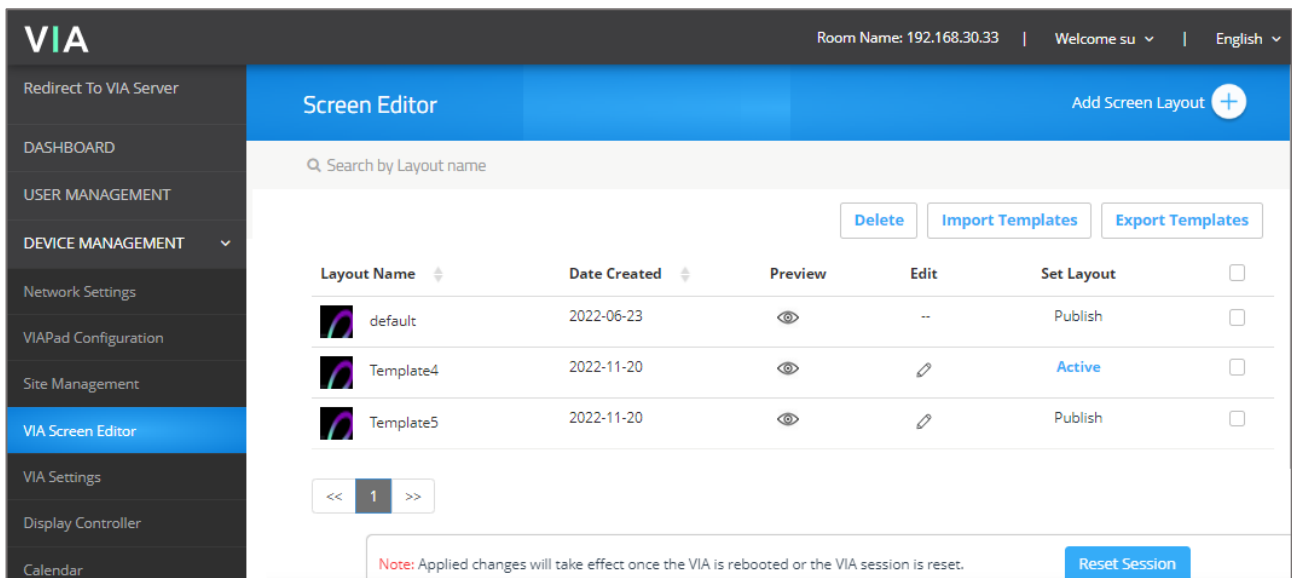

Figure 19: VIA Screen Editor Page

2. Click **Add Screen Layout**.

The wallpaper upload window appears.

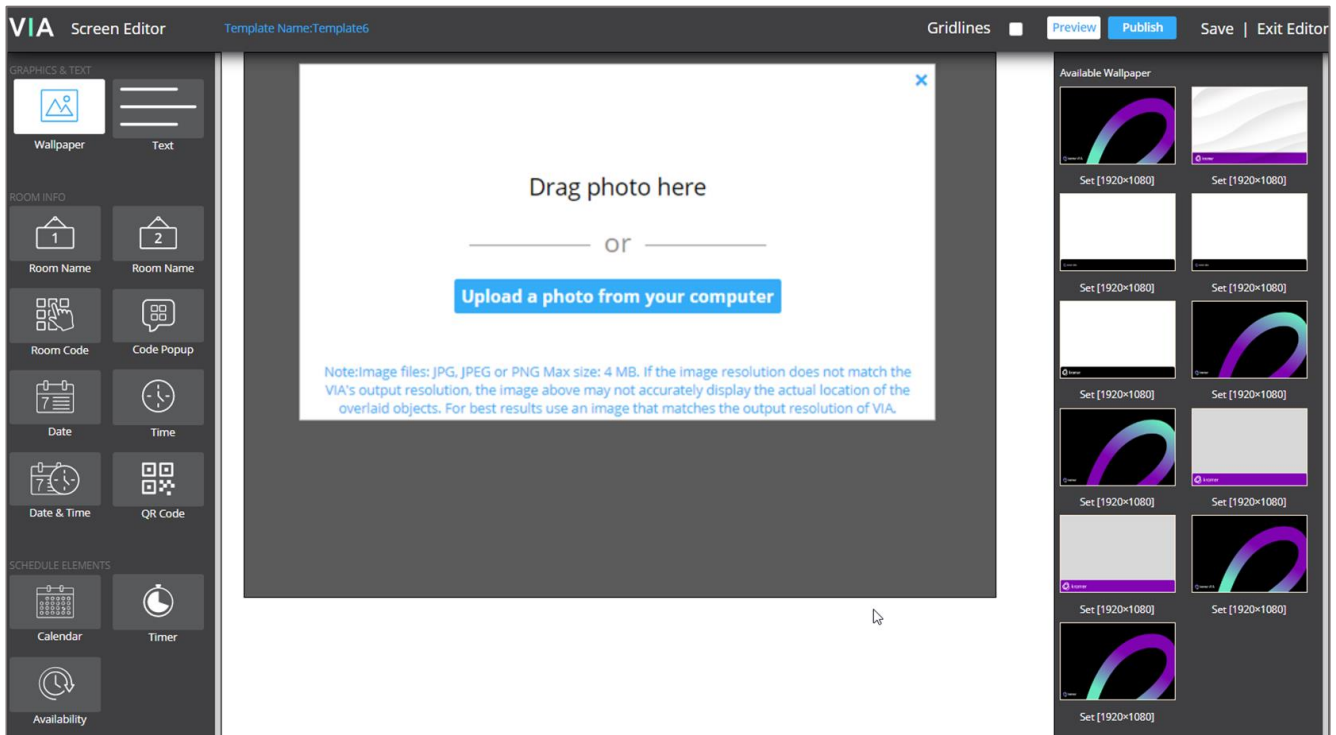

Figure 20: Wallpaper Editor Page

3. Drag an image file to the window or click **Upload a photo from your computer** and select an image file from your computer.



Wallpaper image files must be jpeg, png, or bmp format and a maximum size of 4 MB.

If the wallpaper image resolution does not match VIA's output resolution, the screen layout elements may not appear in the same location as they do in the Screen Editor. For best results, use a wallpaper image that matches the output resolution of VIA.

The Screen Editor window appears with the selected image in the work area.

4. Drag one of the widgets (screen elements) from the left side of the window into the workspace in the middle:
The widget appears on the screen layout preview and the property controls appear on the right of the preview.
5. Format the widget with the property controls on the right side of the window (see [Formatting Screen Layout Widgets](#) on page 27).
6. Click and drag the widgets according to your preferred screen layout.



Select the **Gridlines** checkbox to overlay a grid that helps position elements.

7. Click **Save**.
The new layout is saved and will appear in the table of layouts on the Screen Editor page.
8. Click **Publish**.
The new screen layout appears on the main display.

Formatting Screen Layout Widgets

•

VIA Connect² provides layout widgets (screen elements) for adding items to the Main Display when it is not in use. For example you can use the widgets to set the room code's position, add a customized DNS (Domain Name System) name instead of the default room name or use the calendar to display a list of forthcoming meetings in the room.

Screen Editor Widget formatting:

- [Text – Display Text](#) on page [28](#).
- [Room Name 1 – Set a name for the meeting room](#) on page [29](#).
- [Room Code – Format the four-digit security code](#) on page [30](#).
- [Code Popup – Show a pop-up with the room code when a new participant enters the room name](#) on page [30](#).
- [Date – Show the current date](#) on page [31](#).
- [Time – Show the current time](#) on page [31](#).
- [Date & Time – Show the Date and Time](#) on page [32](#).
- [QR Code – Show a QR code for joining meetings](#) on page [32](#).
- [Calendar – List upcoming meetings](#) on page [33](#).
- [Timer – Show a count-down to the next meeting](#) on page [34](#).
- [Availability – Show how long the room is available for](#) on page [34](#).

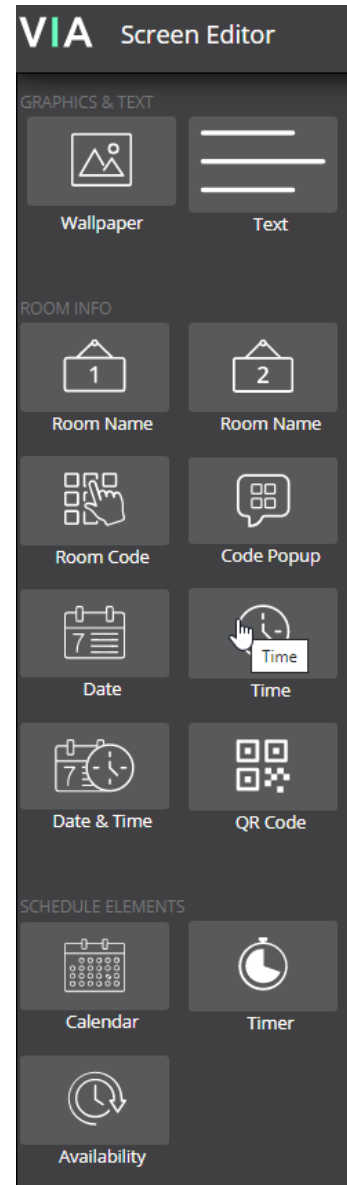

Figure 21: Screen Editor Widgets

Text – Display Text

Add text to the Main Display:

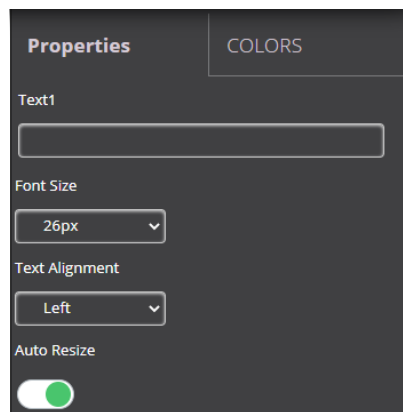

Figure 22: Text Properties Tab

- Enter the text in the **Text1** field.
- Select the **font size** and **text alignment**.
- If Auto Resize is **ON**, the text box on the Main Display automatically adjusts to fit the text when published.

Additional formatting is available on the COLORS tab:

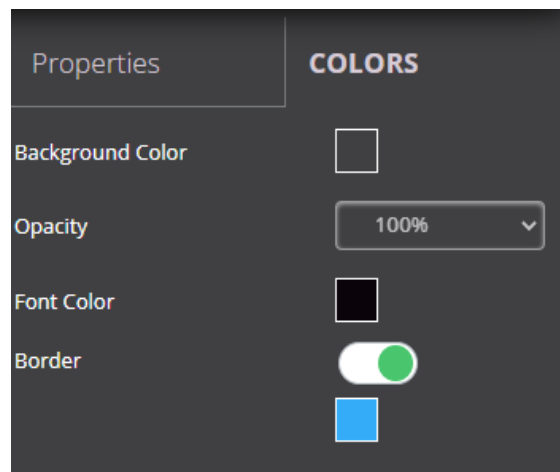

Figure 23: Text Color Tab

- Click the **Background color box** and select a **fill color** for the text box.
- Select the **Opacity** of the text box.
- Click the **Font Color box** and select a **font color**.
- Under Border, click **ON**, click the Border Color box and select a border color.

Room Name 1 – Set a name for the meeting room

Identify the meeting room with a name:

Figure 24: Room Name Properties Tab

- In the Room Name field, enter one or both of the following:
 - #roomname# – By default, this displays the IP address of the meeting space.
 - #airplayname# – By default, displays the airplay name of the meeting space.
- In the **Custom Room Name** field, enter a custom name for the meeting space. This name replaces the meeting space IP address when #roomname# is used in the Room Name field (see bullet above).

 Custom Room Names do not change the IP address. They add a custom name that eases meeting space identification. The custom name appears in the meeting space list with the IP address and participants can use either to join the meeting (see [Joining a Room with the VIA app](#) on page [83](#)).

 Custom room names only work if DNS has been configured to properly redirect the Room Name to the appropriate IP address or if broadcast is working in your network environment. We recommend including the VIA's IP address on the wallpaper as well as the custom name.

- Under Show Room Name on second Display also, click **ON** to show the room name on both displays, when using dual displays (see [Connecting Main Display](#) on page [12](#)).
- Room Name Overlay - Click **ON** to keep the room name on top of content presented on the screen.
- Select how long the room name overlay is visible on top of participant content.
- If Auto Resize is **ON**, the text box on the Main Display automatically adjusts to fit the text when published.

Use the COLORS tab for additional formatting.

Room Code – Format the four-digit security code

Room Code is the four-digit code that participants need to join the meeting.

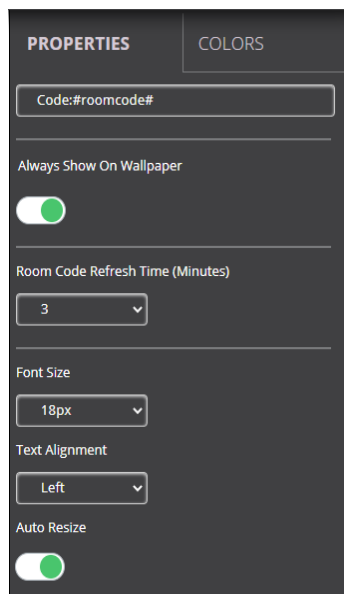

Figure 25: Room Code Properties Tab

- Always show on wallpaper – Set **ON** to always show the room code on the main display background. The code will be hidden if there is content covering it.
- Show Room Code on second Display is for dual displays. Click **ON** to show the room code on both displays.
- Room Code Refresh Time, set the time in minutes after which the room code is changed.
- If Auto Resize is **ON**, the text box on the Main Display automatically adjusts to fit the text when published.
- Use the COLORS tab for additional formatting.

Code Popup – Show a pop-up with the room code when a new participant enters the room name

Code Popup shows the Room Code only when a participant enters the Room Name on **Kramer VIA** app to join the meeting. This popup appears on top of any content being presented on the main display.

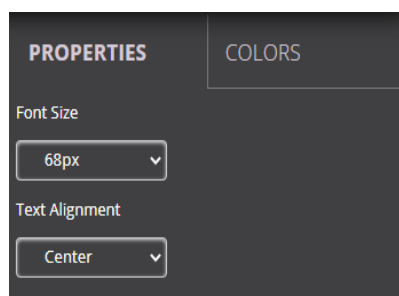

Figure 26: Room Code Popup Properties Tab

- Select the font size and text alignment.
- Use the COLORS tab for additional formatting.

Date – Show the current date

The Date widget displays the date according to the time zone settings of the VIA device (see [Date/Time](#) on page 44).

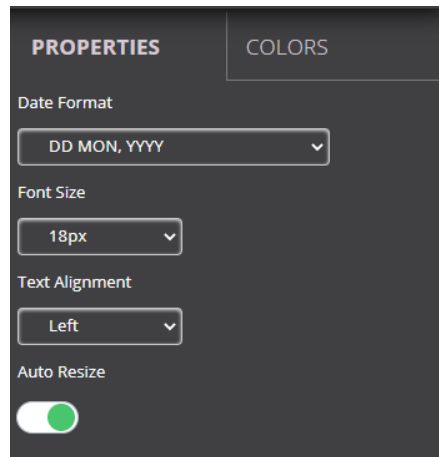

Figure 27: Date Properties Tab

- Select one of the following date formats:
 - **DD MON, YYYY** – Day Month, Year (for example: 1 January, 2019).
 - **MON DD, YYYY** – Month Day, Year (for example: January 1, 2019).
 - **DD MON** – Day Month (for example: 1 January).
 - **MON DD** – Month Day (for example: January 1).
- Select the font size and text alignment.
- If Auto Resize is **ON**, the text box on the Main Display automatically adjusts to fit the text when published.
- Use the COLORS tab for additional formatting.

Time – Show the current time

The Time widget displays the time according to the time zone settings of the VIA device (see [Date/Time](#) on page 44).

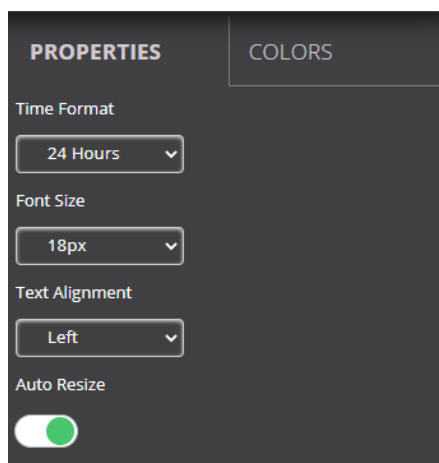

Figure 28: Time Properties Tab

- If Auto Resize is **ON**, the text box on the Main Display automatically adjusts to fit the text.

Date & Time – Show the Date and Time

The Date & Time widget displays both the date and time according to the time zone settings of the VIA device (see [Date/Time](#) on page 44).

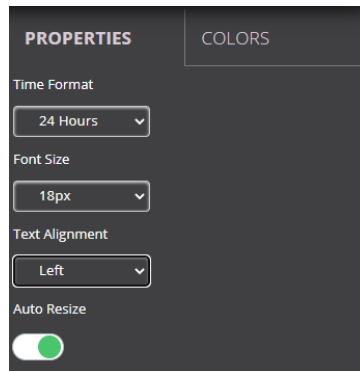

Figure 29: Date & Time Properties Tab

- If Auto Resize is **ON**, the text box on the Main Display automatically adjusts to fit the text when published.
- Use the COLORS tab for additional formatting.

QR Code – Show a QR code for joining meetings

The QR Code widget enables participants to join the meeting by scanning the code.

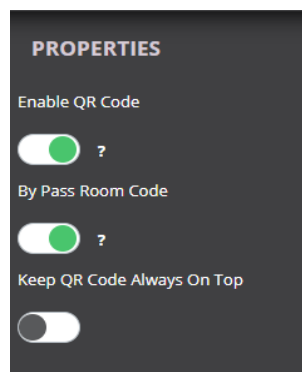

Figure 30: QR Code Properties Tab

- By pass room code – The room code is not required by users who scan the QR code.
- Keep QR code always on top - Show the QR code on top of all content being presented on the screen.

Calendar – List upcoming meetings (Formatting calendar)

The Calendar widget displays information about meetings scheduled in the room where the VIA device resides and can be integrated with Office 365 calendars, Google calendars and MS Exchange calendars.



For more information on entering third party calendar information in the VIA screen editor see [Calendar – Integrating Third Party Calendars](#) on page 56.

Figure 31: Calendar Properties Tab

- Show Title - Show/hide the meeting title.
- Show Organizer - Show/hide the name of the meeting organizer.
- No. of Records to display – Number of upcoming meetings to display
- The COLORS tab provides additional formatting, including bar colors for different meeting statuses (In Use, Available and Upcoming).

Timer – Show a count-down to the next meeting

The Timer widget displays a pop-up that counts down the last minutes before the start of the next meeting.

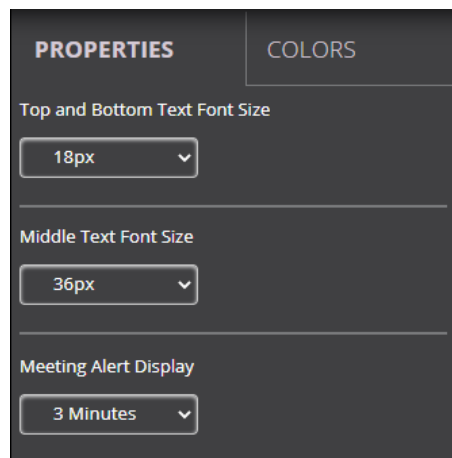

Figure 32: Timer Properties Tab

- Top and Bottom Text Font Size – For text appearing above and below the time.
- Middle Text Font Size - Font size of the time.
- Meeting alert display - The countdown start time before the next meeting.
- The COLORS tab provides additional formatting.

Availability – Show how long the room is available for

The Availability widget is a pop-up that displays meeting space availability in hours and minutes.

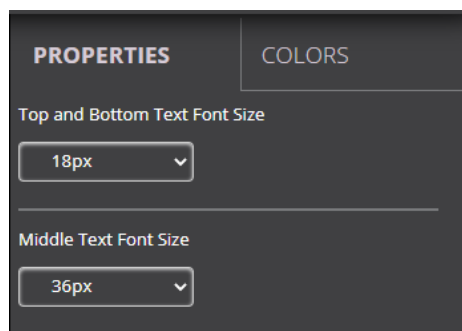



Figure 33: Availability Properties Tab

- Top and Bottom Text Font Size - Font size for text appearing above and below the time.
- Middle Text Font Size - Font size for the time.
- The COLORS tab provides additional formatting.

Editing a Screen Layout

To edit a screen layout:

1. Click **Device Management > VIA Screen Editor** on the navigation pane.
The Screen Editor page appears.
2. Click **Edit**  in the row of the layout that you want to edit.
The Screen Editor window appears.
3. Edit the layout as desired.
4. Click **Save**.
The screen layout edits are saved.

To save the edited screen layout as a new layout:

1. Click the arrow next to Save and select **Save As**.
The template name window appears.
2. Enter a new name for the layout and click **Submit**.
The edited layout is saved as a new layout.

Deleting a Screen Layout

To delete a screen layout:

1. Click **Device Management > VIA Screen Editor** on the navigation pane.
The Screen Editor page appears.
2. Select the layout that you want to delete and click **Delete**.
A confirmation message appears.
3. Click **OK**.
The selected screen layout is deleted from the VIA device and removed from the list.

Exporting and Importing a Screen Layout

VIA Connect² enables you to export a screen layout file for use on other VIA devices.

To export a screen layout:

1. Click **Device Management > VIA Screen Editor** on the navigation pane.
The Screen Editor page appears.
2. Select the checkbox at the end of the row of the layout that you want to export and click **Export Templates**.
A confirmation message appears.
3. Click **OK**.
A screen layout file (screen) is downloaded to your device.

To import a screen layout:

1. Click **Device Management > VIA Screen Editor** on the navigation.
The Screen Editor page appears.
2. Click **Import Templates**.
A file browser window appears.
3. Select the desired screen layout file and click **Choose**.
The selected file is uploaded to **VIA Connect²** and the imported layout appears in the screen layout list.



Make sure that the exported layout file fits the resolution of the VIA device to which it is imported.

➤ VIA Settings

VIA Connect² enables you to configure settings such as power saver, time & date, audio and features availability and save them as part of a settings template. This enables you to define and save different settings for different types of meetings. Just load the appropriate template to match your needs.

To create a new gateway settings template:

1. Click **DEVICE MANAGEMENT > VIA Settings** on the navigation page.
The VIA Settings page appears.

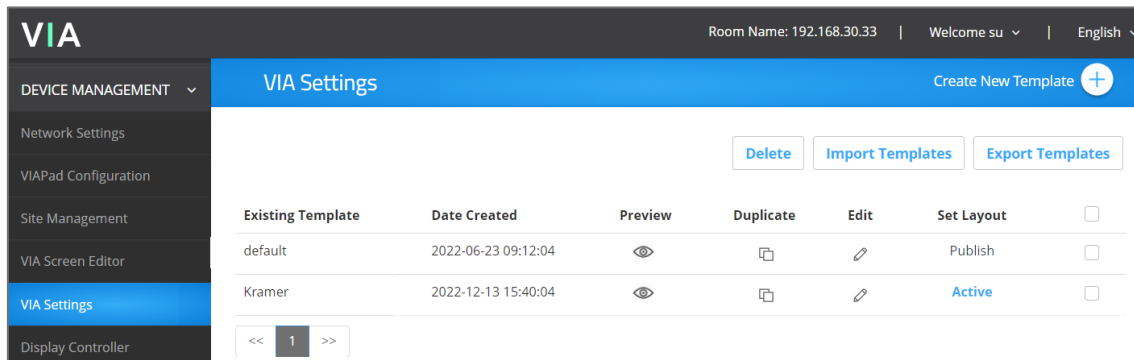

Figure 34: VIA Setting Page

2. Click **Create New Template**.

The Configurations Template Creation page appears.

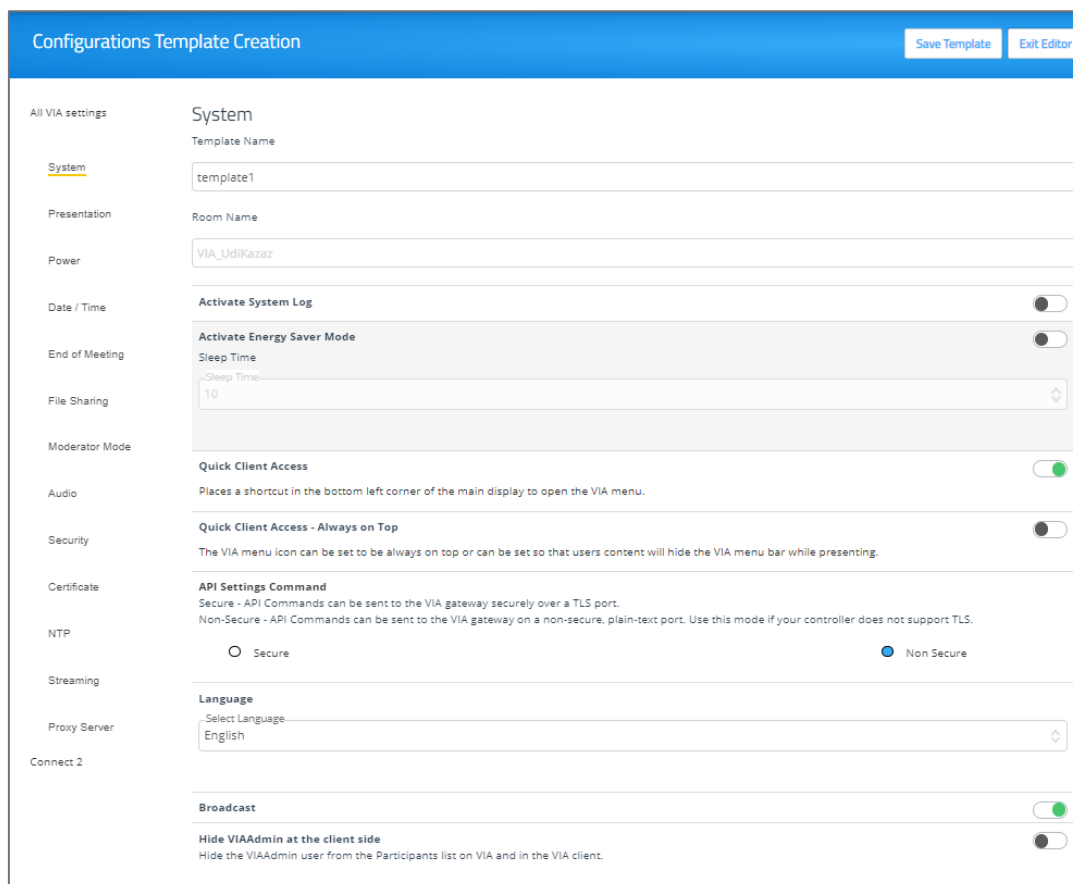

Figure 35: Configuration Template Creation Page

3. Enter a name for the new template and click **Save Template**.

The new template is saved.

4. Open the different settings pages by clicking on the navigation pane on the left and change settings as needed.

5. As you change settings on each page, do one of the following:

- a. Click **Update Template** to update the template without resetting and applying this template.

Changes are saved and the template remains open for more edits.

-OR-

- b. Click **Publish & Exit** to update the template and apply the newly edited template.

Changes are saved to the template, and the session resets with the new template applied. This will take several moments, and you will need to log back into the Gateway Management pages.

VIA Connect² enables you to configure the following types of settings that apply to the settings template:

- [System](#) on page [39](#).
- [Presentation](#) on page [41](#).
- [Power](#) on page [44](#).
- [Date/Time](#) on page [44](#).
- [End of Meeting](#) on page [45](#).
- [File Sharing](#) on page [46](#).
- [Moderator Mode](#) on page [47](#).
- [Audio](#) on page [50](#).
- [Security](#) on page [51](#).
- [Certificate](#) on page [52](#).
- [NTP](#) on page [52](#).
- [Streaming](#) on page [53](#).
- [Proxy Server](#) on page [53](#).
- [Connect 2: Features – Configure Client Menus](#) on page [54](#).

System

Configure the following settings in the VIA settings template (see [VIA Settings](#) on page 37) that affect the overall operation of the system:

The screenshot shows the 'System' settings tab within the 'Configurations Template Creation' interface. The interface has a blue header with 'Configurations Template Creation' on the left and 'Save Template' and 'Exit Editor' buttons on the right. On the left side, there is a sidebar with 'All VIA settings' and a list of categories: System, Presentation, Power, Date / Time, End of Meeting, File Sharing, Moderator Mode, Audio, Security, Certificate, NTP, Streaming, Proxy Server, and Connect 2. The 'System' category is selected and highlighted in yellow. The main content area is titled 'System' and contains the following settings:

- Template Name:** A text input field containing 'template1'.
- Room Name:** A text input field containing 'VIA_UdiKazaz'.
- Activate System Log:** A toggle switch currently turned off.
- Activate Energy Saver Mode:** A toggle switch currently turned off.
- Sleep Time:** A dropdown menu currently set to '10'.
- Quick Client Access:** A toggle switch currently turned on (green).
- Quick Client Access - Always on Top:** A toggle switch currently turned off.
- API Settings Command:** A section with two radio buttons: 'Secure' (unselected) and 'Non Secure' (selected).
- Language:** A dropdown menu currently set to 'English'.
- Broadcast:** A toggle switch currently turned on (green).
- Hide VIAAdmin at the client side:** A toggle switch currently turned off.

Figure 36: System Setting Tab

- Activating System Log** – Provides a log of system activities such as logins, presentation, and VIA features usage to aid in diagnosing a problem or tracking participant usage. (default = OFF)
 - To view and search Activity Logs, (see [Viewing and Searching System Activity Logs](#) on page 68).
- Activate Energy Saver Mode** – Automatically send your **VIA Connect²** unit into sleep mode after being inactive for a defined period of time. After activating this feature, select the period (in minutes) from the Sleep Time field. (default = OFF)
- Quick Client Access** – Display a shortcut in the bottom left corner of the main display to open the **VIA Gateway Dashboard**. (default = OFF)
- Quick Client Access - Always on Top** – When ON, the **VIA Gateway Dashboard** always appears on top of all content on the main display (default = OFF).

- **API Settings Command** – Select one of the following:
 - **Secure** – API Commands can be sent to the VIA Gateway securely over a TLS port.
 - **Non-Secure** – API Commands can be sent to the VIA Gateway on a non-secure, plain-text port. Use this mode if your controller does not support TLS. (default)
- **Language** – Select the language for the Gateway Management pages.
- **Broadcast** – When the user launches the **Kramer VIA** app, all broadcasting VIA gateways appear automatically on the meeting spaces.
- **Hide VIAAdmin at the client side** – Hides the VIAAdmin user from the Participants list. (default = OFF)

Presentation

Configure the following settings in the VIA settings template (see [VIA Settings](#) on page 37) that affect how participants share content during a meeting:

- **iOS Mirroring** – The VIA Gateway will act as an Apple® AirPlay receiver. If desired, type a new Mirror Name (the name that appears when you look for AirPlay devices on your iOS device) and select the maximum number of mirrored iOS devices that can be used simultaneously. (default = OFF)

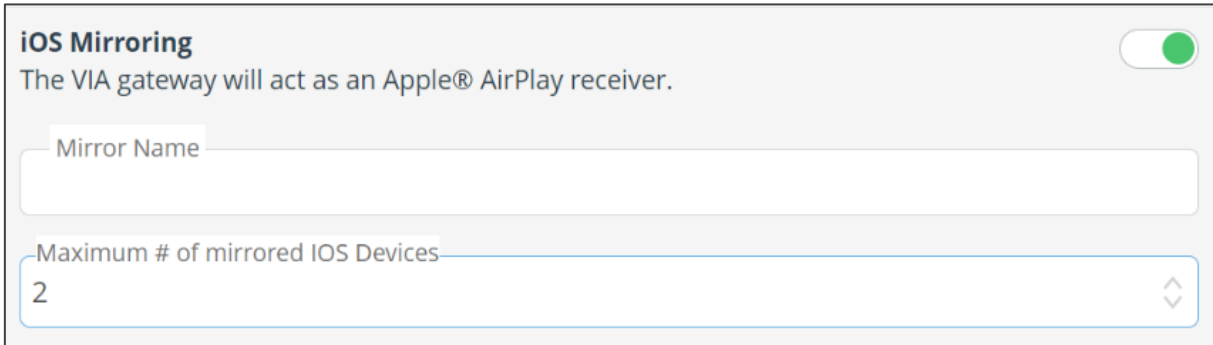

Figure 37: iOS Mirroring Setting Tab

- **Splash screen configuration** – Web Admin can configure splash screen by enabling/disabling the following options:

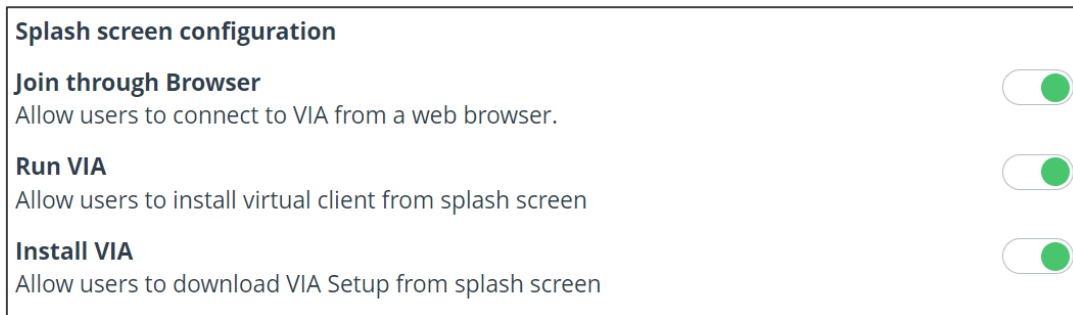

Figure 38: Splash Screen Configuration Tab

- **Join through Browser** – Allow users sitting in the meeting room to join the VIA meeting from a web browser, without downloading any software. (default = ON)
 - **Run VIA** – Enables the user to run the VIA application without downloading any software. (default = ON)
 - **Install VIA** – Enables the user to install VIA client application on personal device. (default = ON)
- **Miracast Settings** – Enables a maximum of 2 users to mirror their device screens using the native Miracast feature on their Windows 10 laptop or Android device without using the VIA app. (default = OFF)



If you are using the built-in WiFi for Client or AP mode, a **VIAcast** dongle (purchased separately) is needed to provide Miracast mirroring for meeting participants. For more information see: www.kramerav.com/product/VIA_Connect?

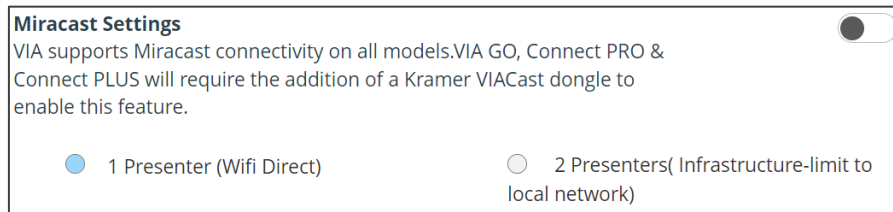

Figure 39: Miracast Setting Tab

Web admin can select the following:

- 1 Presenter – For a single presenter using WiFi Direct. (Default = ON).
- 2 Presenters – For two presenters using local network.
- **Default Encoding for Presentation** – PC & Mac clients connected to the VIA gateway default to the encoding method selected here. (default = Auto/H264).
- **Show Username** – Shows presenter username while presenting (default = ON).
 - **Auto DND** – The DND (Do Not Disturb) feature allows only the active presenter to present and prevents other participants from presenting. Auto DND activates DND when a user starts presenting from their device (default = OFF).

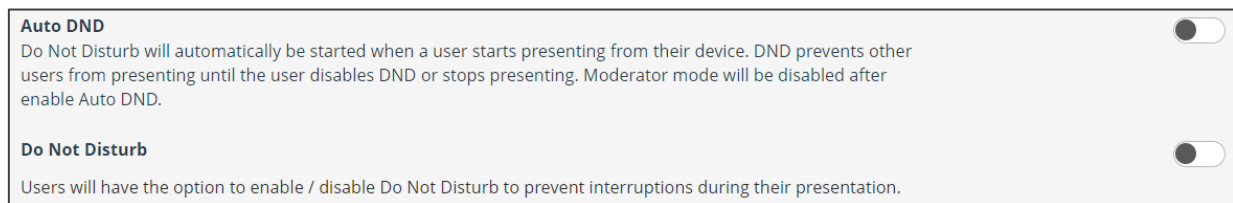

Figure 40: DND Setting Tab

- **Do Not Disturb** – After clicking the Present button, the full screen presenter can enable or disable DND. (default = OFF)
- **Local Annotation** – Users can annotate locally on their device while using the View Main Display feature. If this feature is not activated, users can only view, but not annotate. (default = ON)
- **Public Annotation** – Users can start public annotation while using the View Main Display feature. When public annotation is started, the user's local annotation appears live on the main display, and the whiteboard tools are shown. (default = ON)
- **Presentation Always in full Screen** – Only one user at a time can present. When a new presentation is started, the current presentation stops. (default = OFF)

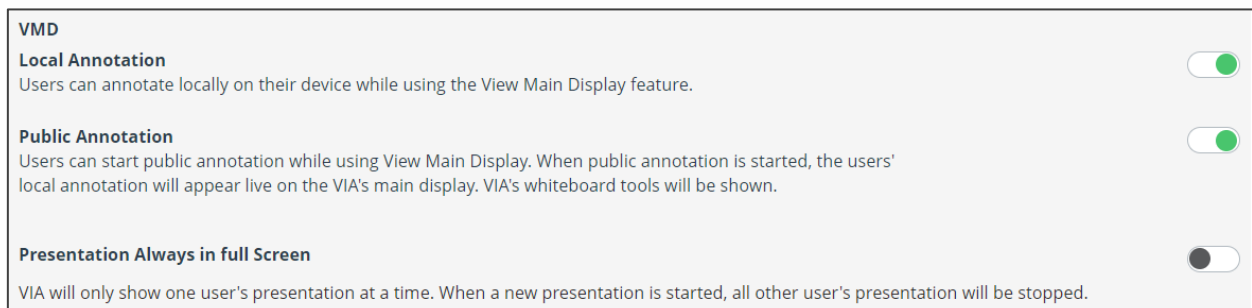
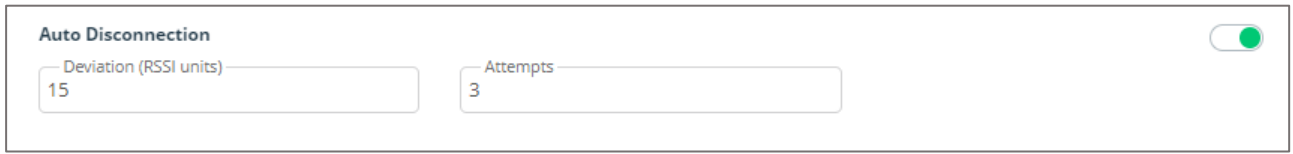

Figure 41: VMD Setting Tab

- **Auto Disconnection** – The VIA device can automatically disconnect participants whose RSSI (received signal strength indicator) is too weak or cannot be measured, indicating that they are too far from the device to be in the meeting room.



The screenshot shows a settings panel for 'Auto Disconnection'. At the top left, the title 'Auto Disconnection' is displayed. To the right of the title is a toggle switch that is currently turned on, indicated by a green circle. Below the title, there are two input fields. The first field is labeled 'Deviation (RSSI units)' and contains the number '15'. The second field is labeled 'Attempts' and contains the number '3'.

Figure 42: Settings Template > Presentation > Auto Disconnection

- **Deviation** – The change in signal strength that will lead to disconnection.
- **Attempts** – The number of reconnect attempts before disconnecting.

It is advisable that you measure the RSSI strength and enter your own settings.

Power

Configure the following energy-saving automatic power settings in the VIA settings template (see [VIA Settings](#) on page 37). Power settings works according to the time zone that the user configures in Date/Time settings (see [Date/Time](#) on page 44):

Power

Auto Power Off Timing
Set a time for the VIA gateway to automatically shut down each day.

Time of Day - Hours: 00
Minutes: 00

Auto Reboot Timing
Set a time for the VIA unit to automatically reboot each day.

Time of Day - Hours: 00
Minutes: 00

Figure 43: VIA Power Setting Tab

- Auto Power Off Timing – Set a time for **VIA Connect²** to automatically shut down each day. (default = OFF)
- Auto Reboot Timing – Set a time for **VIA Connect²** to automatically reboot each day. (default = OFF)

Date/Time

Configure the following settings in the VIA settings template (see [VIA Settings](#) on page 37) that define the date and time displayed on the Gateway Management Pages:

Date/Time

Date and Time Format for Web interface
Date Time Format: Y-m-d HH:MM:SS

VIA Gateway Timezone Configuration
Sets the Timezone on the VIA gateway.
Timezone: Asia/Kolkata

Figure 44: Date/Time Setting Tab

- Date and Time Format for Web Interface – Select the format for displaying the date and time on the User Dashboard page.
- VIA Gateway Timezone Configuration – Select the time zone for **VIA Connect²**.

End of Meeting

Select what happens to the Whiteboard when all participants have disconnected from a VIA meeting:

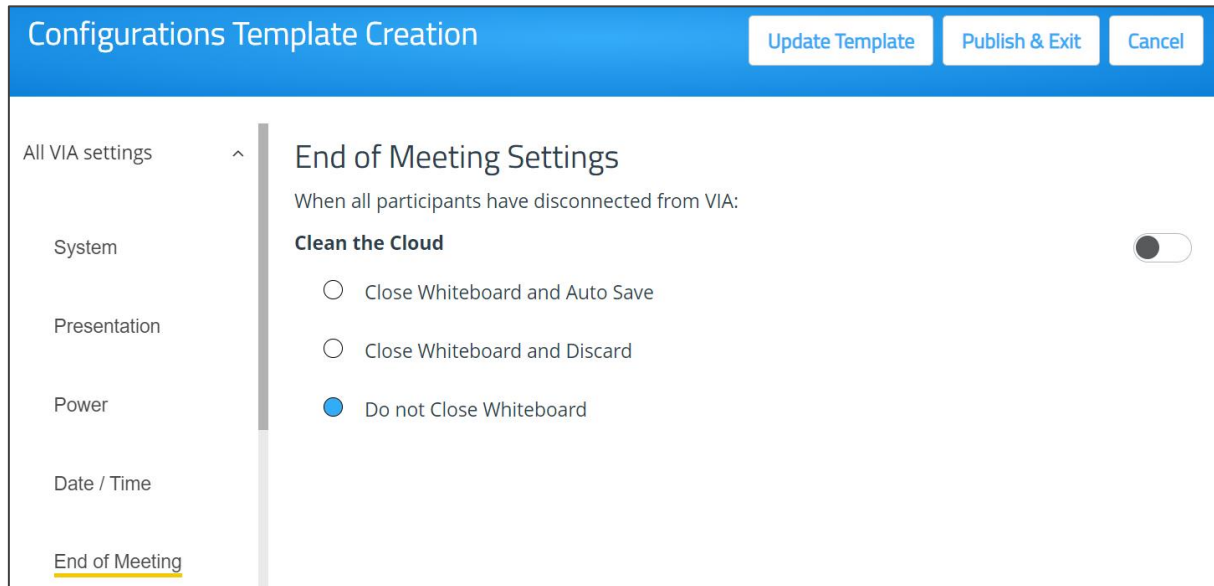

Figure 45: End of Meeting Setting Tab

- **Clean the Cloud** – Deletes all the whiteboard files stored in the VIA cloud (default = OFF).
- Select one of the following Whiteboard options:
 - **Close Whiteboard and Auto Save** – Closes the Whiteboard on the main display and saves the current page to the VIA cloud.
 - **Close Whiteboard and Discard** – Closes the Whiteboard on the main display and discards the current page.
 - **Do not Close Whiteboard** – The current whiteboard page remains on the main display.



The Whiteboard is described in [Using the Whiteboard](#) on page [98](#).

File Sharing

Place limits on the file types that can be shared between participants:

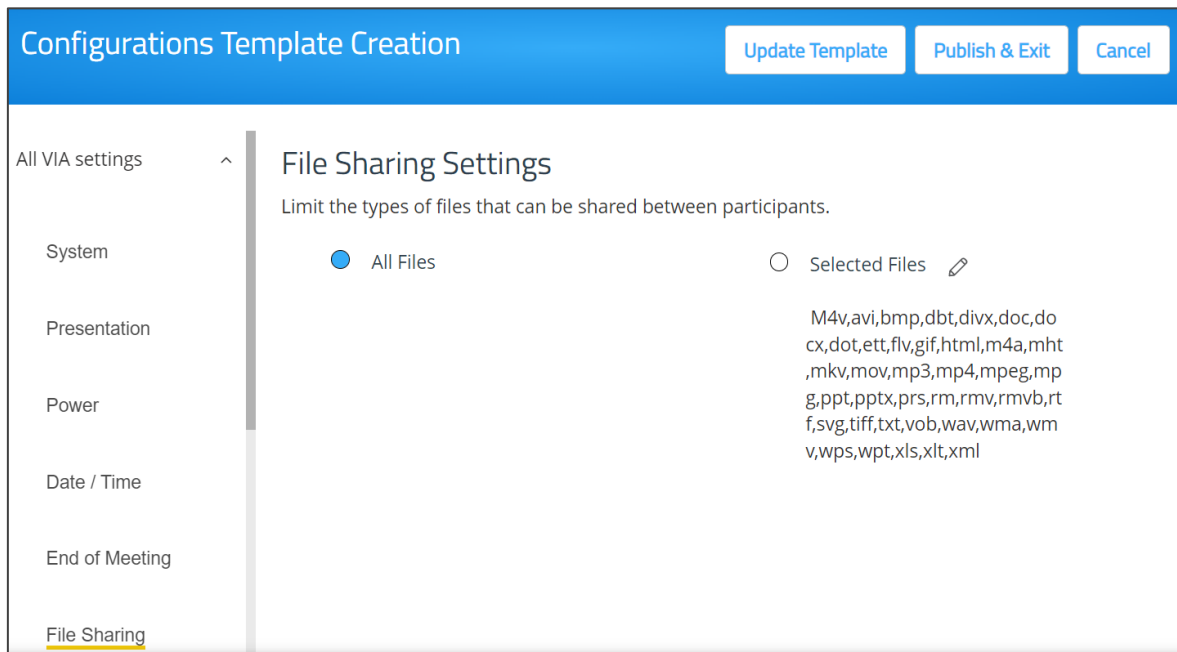

Figure 46: File Sharing Setting Tab

- **All Files** – Share any type of file between participants.
- **Selected Files** – Click the edit icon to add or remove file types from the allowed list.

Moderator Mode

Moderator Mode settings define who can become the meeting moderator and what features are activated when a participant becomes the moderator.

The following settings in the VIA settings template (see [VIA Settings](#) on page 37) affect Moderator Mode.

When Moderator Mode is activated, the Moderator icon appears on the VIA User Dashboard of eligible participants (see [Moderating - Controlling the Meeting](#) on page 95) .

Figure 47: Moderator Mode Setting Tab

1. Select who can join a meeting and who can become moderator:

- **Database Based** – Only users with accounts created in **VIA Connect²** database can join a meeting and become moderator (see [User Management](#) on page 16).
- **Active Directory** – Only users defined in the Active Directory can join a meeting and become moderator (see [Configuring Active Directory Moderator Mode](#) on page 48).
- **Basic** – Anyone can join a meeting and become moderator. A password can be entered for use by moderators, (see also [Security](#) on page 51).

 Configure “Database based” or “Active Directory” in moderator mode to define who can join the VIA meeting.



2. Moderator checkboxes:

- **Moderator can enable/disable Chat.**
- **Allow Participant to confirm start of Presentation** – The moderator must approve screen sharing before it starts.
- **Wait for Moderator to Start Session** – The VIA session does not start until a moderator joins the meeting. User Dashboard features are grayed out and a message appears on the main display.

 This feature is not available in Basic Moderator Mode.

Configuring Active Directory Moderator Mode

Active Directory users can be imported into **VIA Connect²** Gateway Management Pages. The Active Directory must be organized into two sets of users: one that has permission to become moderator and one that does not have moderator permission. When using Active Directory, only users who are in the directory can join a VIA meeting.

-  Active directory mode enables displaying user's First name and Last name while using VIA features such as "Chat", "Present", "File transfer", "Enable DND", "Mouse hover", "Activity Log", etc.
-  Use Groups or OUs (Organizational Units) to divide the moderator and participant/non-moderator set of users.
-  Do not use Groups or OUs that have employees in common. If users overlap in your existing Groups, you will have to create new Groups for this purpose.

To configure Active Directory Moderator Mode:

1. On the VIA setting Template, select Moderator Mode tab (see [Moderator Mode](#) on page 47).

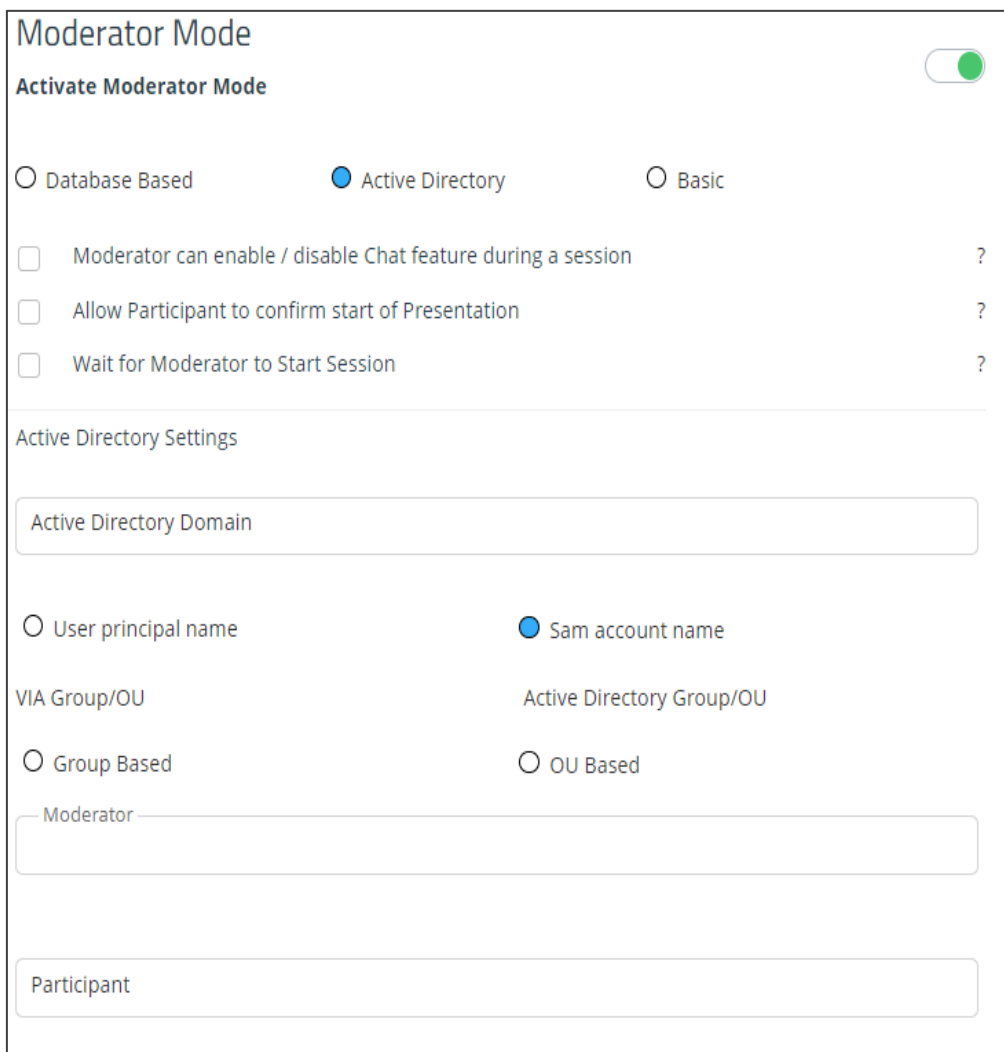

Figure 48: Active Directory Moderator Mode Setting Tab

2. Click the Activate Moderator Mode switch and select Active Directory.
The Active Directory settings appear.
3. In the **Active Directory Domain** text box, enter the Active Directory domain name.
4. Select User principal name or Same account name.
5. Select the **Group Based** or **OU Based** radio button as per your Active Directory configuration.
6. Based on the above selection, type the name of the Moderator and Participant Group/OU in their respective boxes.
7. Login the Gateway Dashboard settings (see [Logging in to the Gateway Dashboard](#) on page 73) and select LAN settings.
8. Click on the Host Configurator.
The Host configuration page appears.

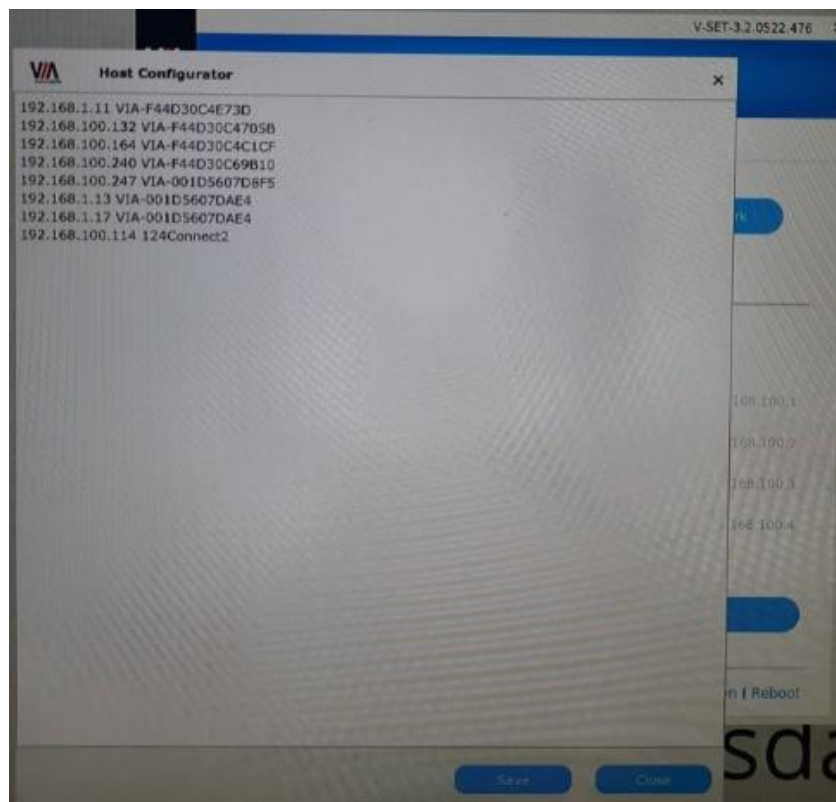

Figure 49: Host Configuration Page

9. On the Host Configuration page, enter the **Active Directory server IP >> Space >> Active Directory Domain Name** and click **Save**.

Active Directory Moderator Mode is configured.

i **VIA Connect²** does not discover and connect to the Active Directory; rather it relies on you to correctly enter the details. If there is a typographical error in any of the fields, the users (Moderators and Participants) cannot log in.

i For further details, refer to “VIA Integration into DNS and Microsoft Active Directory” white paper.

Audio

Configure the following audio related settings in the VIA settings template (see [VIA Settings](#) on page [37](#)):

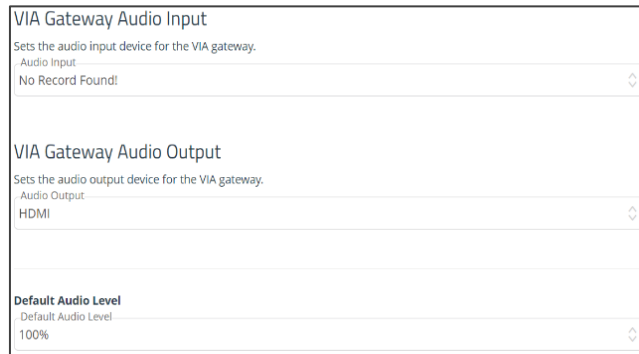

The screenshot displays a settings interface for the VIA Gateway Audio. It is organized into three distinct sections, each with a title, a brief description, and a dropdown menu for configuration.

- VIA Gateway Audio Input**: The description is "Sets the audio input device for the VIA gateway." The dropdown menu is currently set to "No Record Found!".
- VIA Gateway Audio Output**: The description is "Sets the audio output device for the VIA gateway." The dropdown menu is currently set to "HDMI".
- Default Audio Level**: The description is "Default Audio Level." The dropdown menu is currently set to "100%".

Figure 50: VIA Gateway Audio Setting Tab

- VIA Gateway Audio Input – Set the audio input device for the User Gateway.
- VIA Gateway Audio Output – Set the audio output device for the User Gateway.
- Default Audio Level – After rebooting the unit, resetting a session, or returning to a meeting after all users have logged off, the volume returns to 100%.

Security

Configure the following settings in the VIA settings template (see [VIA Settings](#) on page 37) that affect login security for the Gateway Management Pages and for VIA meetings:

The screenshot shows a 'Security' settings tab. It includes a 'Web Session Timeout' section with a 'Session Timeout' input field containing '24 Hours'. Below that is a 'Captcha' section with the text 'Enable or Disable captcha for web admin login.'. The 'Password Policy' section has a note 'Settings designated below will be enforced for created user accounts.' and lists requirements: 'Alphanumeric', 'At least one special character', and 'At least one capital letter'. There is a 'Password minimum length' input field with the value '4'. The 'Apply password policy on basic mode' section has a note 'VIA basic password'.

Figure 51: VIA Security Setting Tab

- **Web Session Timeout** – Select the amount of idle time before an administrator is automatically logged out of the Gateway Management Pages.
- **Captcha** – Turn ON or OFF the captcha challenge when logging into the Gateway Management Pages.

The following Password Policy settings affect new user accounts for logging into the Gateway Management Pages and joining a VIA meeting:

- **Alphanumeric** – Require at least one letter and one number to be included in a user password.
- **At least one special character** – Require at least special character (like: !, @, #) to be include in a user password.
- **At least one capital letter** – Require at least one capital letter to be include in a user password.
- **Password minimum length** – Define a minimum number of characters for a user password.
- **Apply password policy on basic mode** – Require all the above rules when creating the Basic mode password (below).
- **VIA basic password** – Define the password needed to become moderator when in Basic mode (see [Moderator Mode](#) on page 47). To remove the password requirement, clear the password field.

Certificate

A custom SSL certificate can be uploaded to **VIA Connect²** to better provide for the security needs of your organization.

 To prevent damage to the system, make sure you upload files that can be used by the system. If you are unsure of how to use this feature, contact technical support.

For information on how to create a certificate, see [Creating an SSL Certificate for VIA](#), available at: [www.kramerav.com/product/VIA_Connect²](http://www.kramerav.com/product/VIA_Connect2)

After obtaining your certificate, install it on your VIA device.

 The uploaded files must stay in the format of “server.crt” & “server.key”.

To upload an SSL certificate:

1. On the Certificate tab in the VIA settings template (see [VIA Settings](#) on page [37](#)), copy and paste the web server certificate.

The web server certificate is uploaded.

 Do not upload the key file until the certificate file is finished uploading.

2. Copy and paste the key file; The key file is uploaded.

NTP

An NTP (Network Time Protocol) server can be used to synchronize the time on **VIA Connect²**.

To add an NTP server:

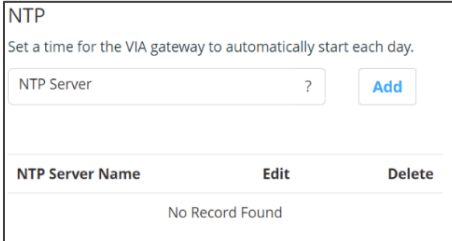

NTP Server Name	Edit	Delete
No Record Found		

Figure 52: NTP Server Setting Tab

1. In the NTP tab in the VIA settings template (see [VIA Settings](#) on page [37](#)), enter the NTP server address and click **Add**.

The new NTP server is saved and appears in the NTP Server table.

 To edit an NTP server name, click the icon in the Edit column.

To delete an NTP server name, click the icon in the Delete column.

Streaming

This setting is used for the streaming feature. For more information, see [Streaming a Meeting Session](#) on page [105](#).

Proxy Server

A proxy server can be used to handle all URLs used during VIA meetings (for example, Youtube URLs used for the Youtube player feature) and for firmware downloads.

To define a proxy server:

- In the Proxy Server tab in the VIA settings template (see [VIA Settings](#) on page [37](#)), enter your proxy server parameters.



After entering the parameters, click **Test Proxy Server** to verify that all parameters were entered correctly and that a connection has been established.

Connect 2: Features – Configure Client Menus

Use these options to reorganize the VIA Connect² user menu and hide menu options.

The following menus can be changed:

- **Gateway Features** – The menu shown on the main display.
- **Client Features** – The menu shown on participants' laptops and tablets.
- **Mobile Features** – The menu shown on participants' smartphones.

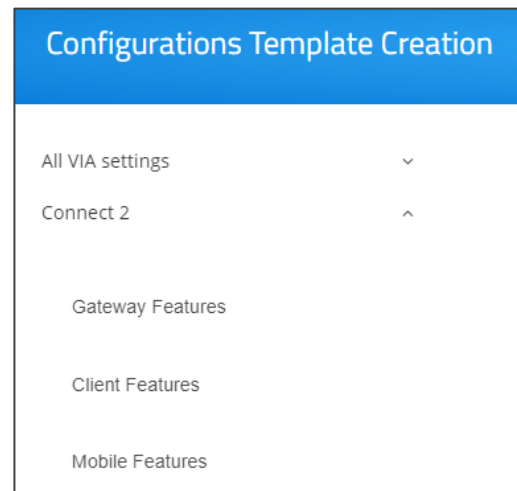

Figure 53: Features Menu Setting Tab

To organize the menus shown to participants:

1. Scroll down on the Configurations Template Creation navigation pane and click **Gateway Features** or **Client Features** or **Mobile Features**.
2. Click and drag feature icons to a new position as needed.
3. Enable or disable the features by clicking the switch (green= enabled).
Hidden (disabled) features move to the bottom of the list.

After changing the menu, click **Update Template** and then click **Publish & Exit**.

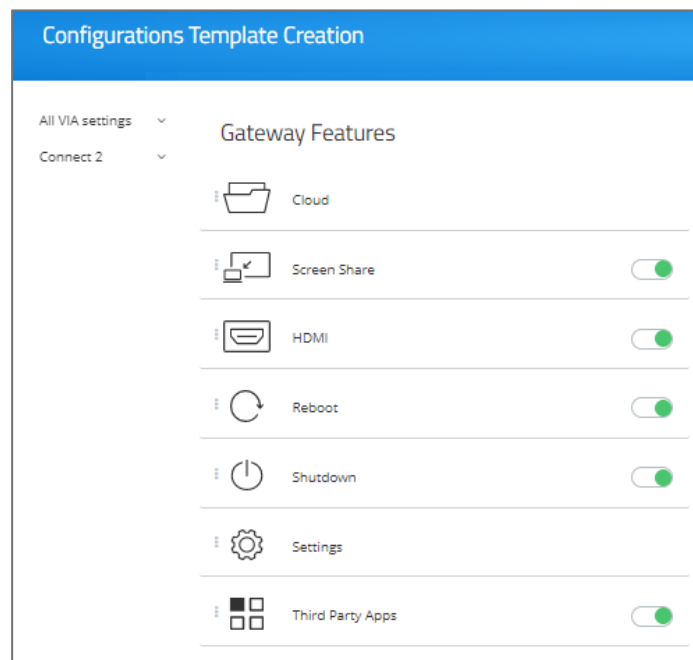

Figure 54: VIA Connect² Features Tab

➤ Display Controller

VIA Connect² enables you to control a display screen that is connected to the same network as your **VIA Connect²**.

This feature enables you to configure one of the following actions:

- When the first person joins the meeting, the main display powers ON and when the last person logs out of the meeting, the main display powers OFF.
- Send a switch HDMI Input command, to toggle between the VIA input and any other device connected to the same display.

To configure your VIA Connect² as a display controller:

1. Connect the display to be controlled to the same network as your **VIA Connect²**.
2. Click **Device Management > Display Controller** on the navigation pane.

The Display Controller page appears.

Figure 55: Display Controller Settings

3. Click the **Activate Control** switch.
4. Enter the Display IP address and Display Control Port of the display screen to be controlled.
5. For Command 1, enter the command to send when someone first joins a meeting (for example, power ON the display).
6. For Command 2, enter the command you want the VIA to send when the last participant logs out of the meeting (for example, power OFF display).
7. Select **ASCII** or **HEX** to define command format accepted by your display.



Refer to the User Manual for your display for the correct format of the commands.

Configuring your **VIA Connect²** as a display controller is complete.

➤ Calendar – Integrating Third Party Calendars

VIA Connect² enables you to display scheduled meeting information on the main display home screen. VIA automatically retrieves information about meetings scheduled in the room where the VIA device resides. This feature is available for a room that has been added in Office 365[®] Admin Center, Microsoft Exchange[®] or in Google[®] Admin Console for G Suite[®].



Before configuring this feature in the VIA Gateway Management Pages, you must add the room in either Office 365 Admin Center, Microsoft Exchange or Google Admin Console for G Suite.

Integrating Office 365 Calendar

To integrate your Office 365 Calendar with VIA Calendar:

1. Click **Device Management** > **Calendar** on the navigation pane.
The Calendar Account displays with Office 365 Basic Auth selected.
2. Select **Office 365 Basic Auth** from the Calendar Type drop down.
3. Enter the following for the room where this VIA gateway resides:
 - **Username** – Email address assigned to the room.
 - **Password** – Password associated with the room Username.
4. Select a Permission Type for the user:
None, Impersonation, Delegate.

Figure 56: Third Party Calendar Configuration Page

- **Impersonation** - Gives the device full access to the calendar (less secure).
- **Delegate** – You will need to specify which parts of the calendar can be used.

5. In Resource Calendar, enter a calendar name to identify the created calendar.



Enabled when Impersonation or Delegate are selected.

6. Click **Test & Save** to test if the details entered are correct.
Your Office 365 calendar is integrated with VIA Calendar.

Integrating Microsoft Exchange

When a resource mailbox (e.g., a meeting space) is created, the Exchange® administrator can synchronize with the mailbox to be none, an Impersonation, or a Delegate.

To integrate Microsoft Exchange with VIA Calendar:

1. Click **Device Management** > **Calendar** on the navigation pane.
The Calendar Account displays.
2. Select the **Activate Calendar** checkbox.
3. Select **MS Exchange** from the Calendar Type drop down.
The MS Exchange controls appear.
4. Enter the server URL.
5. Select the relevant version of Microsoft Exchange.
6. Enter the following for the meeting space where this VIA gateway resides:
 - **Username** – Email address assigned to the meeting space.
 - **Password** – Password associated with the meeting space Username.
7. Select a **Permission Type** for the user: **None**, **Impersonation**, **Delegate**.
 - **Impersonation** - Gives the device full access to the calendar (less secure).
 - **Delegate** – You will need to specify which parts of the calendar can be used.
8. **Resource Calendar** is enabled when Impersonation or Delegate are selected;
Enter a calendar name to identify the created calendar.
9. Click **Test & Save** to test if the details entered are correct.
Microsoft Exchange is integrated with VIA Calendar.

Integrating a Google Calendar

To integrate your Google Calendar with VIA Calendar:

1. Click **Device Management** > **Calendar** on the navigation pane.
The Calendar Account displays.
2. Select **Google** from the Calendar Type drop down.
The Google Calendar controls appear.
3. Click **Click here to get code**; Google sign in page appears.
4. Sign-in with the Google account where the shared space calendar was created.
5. Allow access to VIA-Calendar; An integration code appears.
6. Copy the integration code from the Google sign in page and paste it into the Step 2 field on the VIA Calendar page.
7. Click **Get Calendar**.
8. In the Select the calendar field, select the calendar associated with the room.
9. Click Associate; Your Google Calendar is integrated with VIA Calendar.

➤ Third Party Apps

Adding third party apps. **Device Management > Third Party Apps** updates, adds or deletes apps that can be opened in the VIA app by meeting participants or by the presenter / moderator on the Main Display.

- Third party apps can be enabled or disabled in the **Gateway Management pages, Device Management > VIA Settings > Connect 2 Features** (see [Connect 2: Features – Configure Client Menus](#) on page 54).

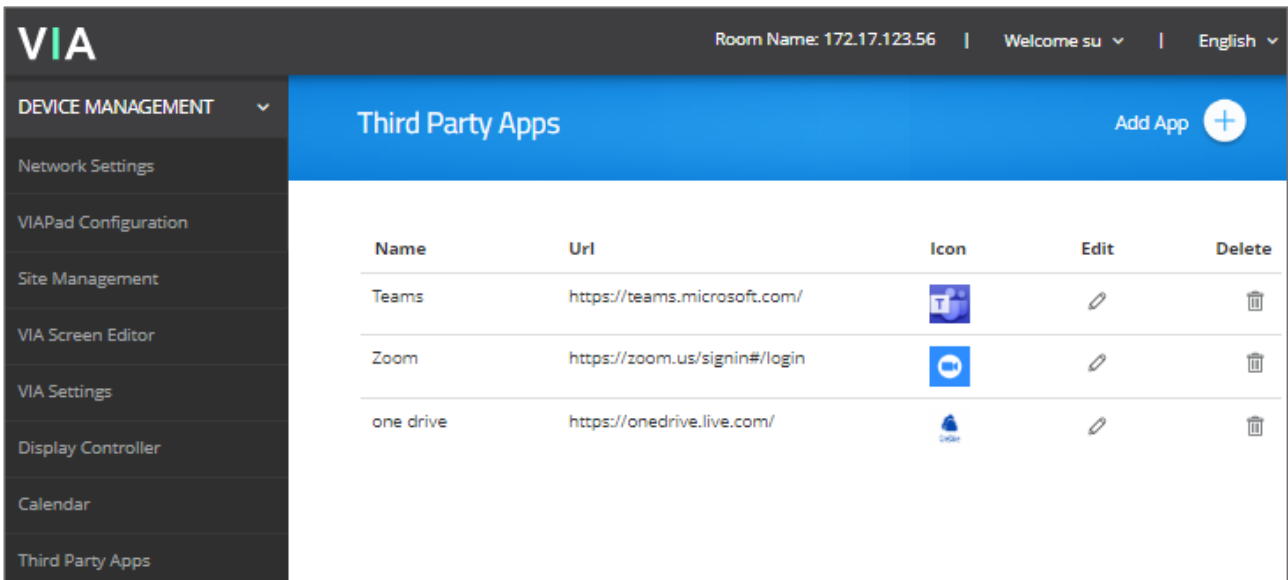

Figure 57: Third Party Apps menu

- Click **Add App+** to add an app.
- The **icon** and **name** will be shown to meeting participants in the User Dashboard when they click App or in the Gateway Dashboard Features menu. (see [The Features Menu](#) on page 102).

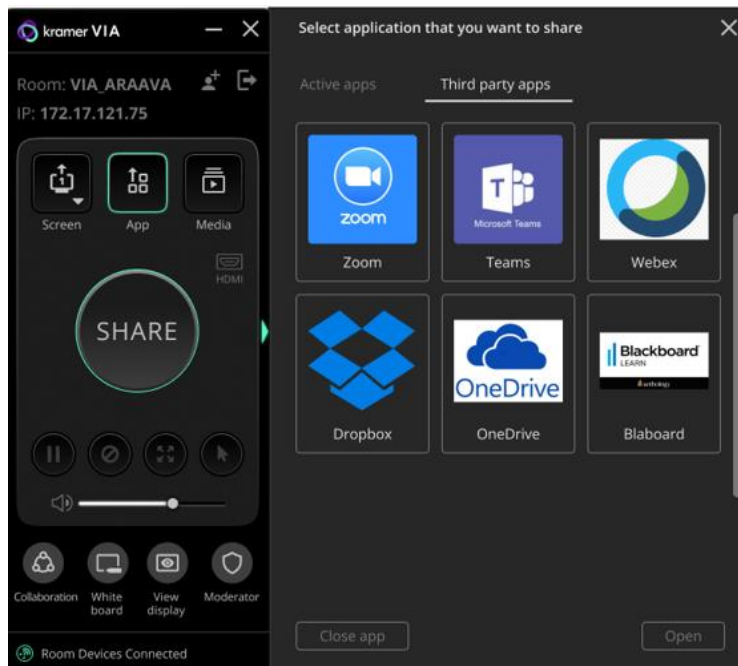

Figure 58: Third Party Apps Display in the User Dashboard

Digital Signage



For VIA devices sold before June 1st, 2019, Digital Signage is an optional feature available through separate licensing and pricing. Contact your local Kramer office for more details.

VIA Connect² Digital Signage displays dynamic content and information on the main display when there is no meeting in progress. Use a predefined template or create your own display layout with up to three frames of content that appear simultaneously. Then, schedule the content to run automatically at specific dates and times.

Configuring digital signage includes the following steps:

- [Manage Content](#) on page [59](#).
- [Template Manager](#) on page [63](#).
- [Campaign Editor](#) on page [65](#).
- [Schedule Campaign](#) on page [66](#).

Manage Content

VIA Connect² enables you to create a library of media content to be displayed through the digital signage feature. The types of media that can be displayed are:

- Scroller – A custom text message that scrolls across the screen.
- RSS – Live RSS feed.
- Web URL – A live web page or HTML file.
- Media – Static image (jpg, jpeg, bmp, gif, png) or Video (avi, mpeg, wmv, mpg, mov, vob, mkv, mp4, m4v).

To create and upload digital signage media:

1. Click **Digital Signage > Manage Content** on the navigation pane.

The Manage Content page appears.

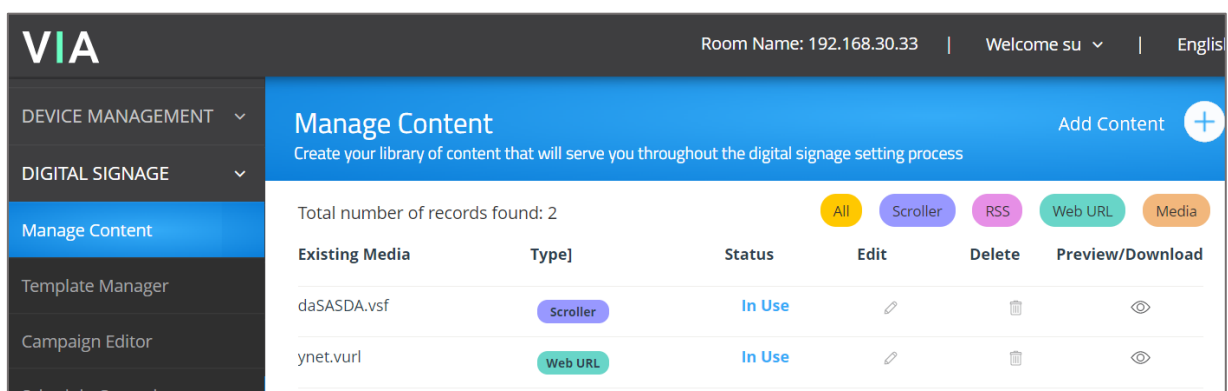

Figure 59: DSS Content Manage Page

2. Create and upload media, as required:
 - [Creating Scrolling Text](#) on page [60](#).

- [Adding an RSS Feed](#) on page [61](#).
- [Adding a Web URL](#) on page [61](#).
- [Uploading Media Files](#) on page [62](#).

Creating Scrolling Text

To create scrolling text:

1. On the Manage Content page, click **Add Content**.

The Add Content pane appears with the Scroller tab open.

2. Type the text to be displayed in the box.
3. Type a name for the scroller in the Scroll Name text box.

4. Set the scroll speed.

- i Set the scroll speed to **Zero**, to create a static text display that does not scroll.

5. Set the font parameters.

- i To add a font, click **Upload Font**.

Figure 60: Scrolling Text Setting Tab

- i The following variables can be entered into the text field:

- #airplayname# – Displays the airplay name.
- #roomname# – Displays the room name/code for joining into the meeting.
- #appass# – Displays the Access Point password.
- #apname# – Displays the Access Point name.
- #ipaddress1# – Displays the IP address for the primary network.
- #ipaddress2# – Displays the IP address for the second network, if in use.

6. Set the background color.

7. Click **Create**.

The Scroller is created and added to the **Existing Media** table (in the Manage Content page).

Adding an RSS Feed

To add an RSS feed:

1. On the Manage Content page, click **Add Content**.
The Add Content pane appears with the Scroller tab open.
2. Click **RSS**.
The RSS tab appears.
3. Enter the RSS feed's URL address.
4. Click **Get tags** and select the required tag from the Select a tag drop-down list.
5. In the RSS Name field, enter a name for the RSS feed that will appear in the Existing Media table.
6. Under options, select the speed, display style, font settings and background color for the RSS feed.
7. Click **Create**.
The new RSS feed is added and appears in the Existing Media table.

Figure 61: RSS Setting Tab

Adding a Web URL

Add the URL of an existing web page or use a third-party solution (for example, Google Slides) to publish a presentation to the web and add the URL of the presentation.

To add a web URL for digital signage:

1. On the Manage Content page, click **Add Content**: The Add Content pane appears with the Scroller tab open.
2. Click **Web URL**; The Web URL tab appears.
3. Select the **Auto Refresh** checkbox to display a URL with dynamic content
OR
Clear the **Auto Refresh** checkbox to display a URL as a static page.
4. Type the URL address and File Name and click **Create**: The new URL is added and appears in the Existing Media table.

Figure 62: Web URL Setting Tab

Uploading Media Files

To upload media files:

1. On the Manage Content page, click **Add Content**.
The Add Content pane appears with the Scroller tab opens.
2. Click Media; The Media tab appears.

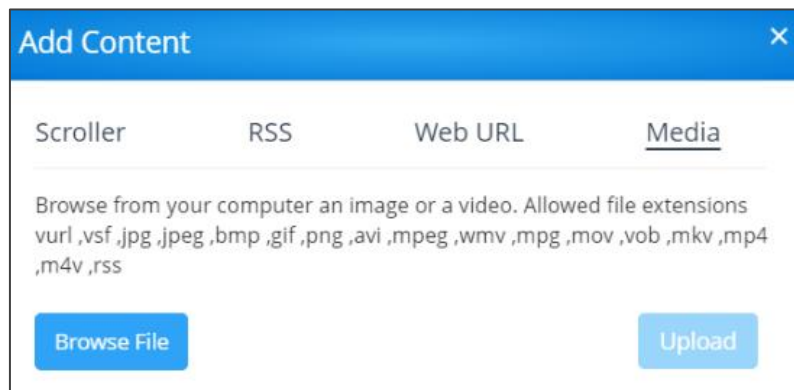

Figure 63: Media Setting Tab

3. Click **Browse File**.
A file browser appears.
4. Select an image or video file and click **Upload**.
The file is added and appears in the Existing Media table.

Template Manager

Templates dictate the layout of the digital signage content. Up to 3 frames of content can be displayed at once. **VIA Connect²** enables you to use predefined templates and to create custom templates.

To create a custom digital signage template:

1. Click **Digital Signage > Template Manager** on the navigation pane.

The Template Manager page appears with **Pre-Defined** Templates tab open.

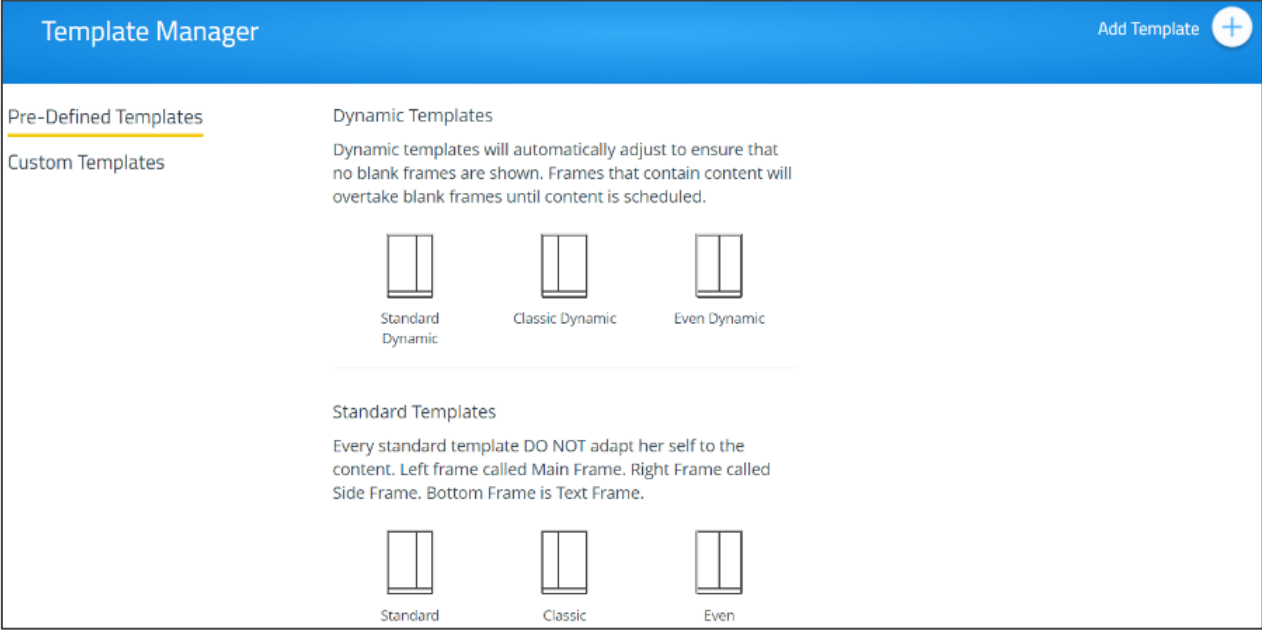



Figure 64: DSS Template Setting Page

 The Pre-Defined Templates tab explains all the pre-defined templates that are available when you create a campaign

2. Click **Custom Templates**; The Custom Templates tab appears.
3. Click **Add Template**; The Add Template pane appears.

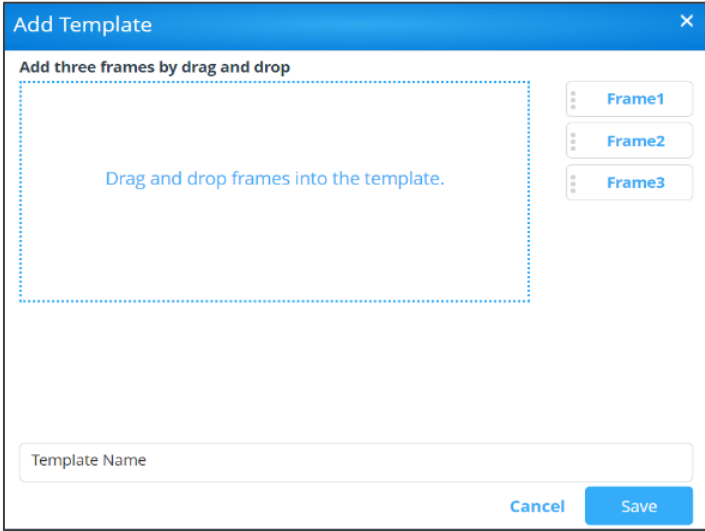

Figure 65: Add Template Pane

4. Type a name for the new template in the Template Name text box.
5. Click and drag one of the frames into preview box.
The frame parameters for the frame appear below the preview.
6. Click and drag the box to move and resize it.
7. Select the **Audio** checkbox to play audio from the selected frame.



Only one frame can include audio.

8. Repeat steps 5–9 to add up to two more frames.



The layering order of the frames, from bottom to top is Frame 1, Frame 2, Frame 3.

9. Click **Save**.

The new template is added and appears in the Saved Templates table on the Custom Templates tab.



Click the Preview icon for a template to see a preview.



Click the **Edit** icon to open the template builder screen and edit the selected template.

Templates that are In Use (i.e. they have been used to configure a campaign (see [Campaign Editor](#) on page [65](#)) cannot be edited.



Click the **Delete** icon to delete the selected template.

Campaign Editor

A Digital Signage Campaign defines what is displayed in each frame of a digital signage template layout.

To configure a digital signage campaign:

1. Click **Digital Signage > Campaign Editor** on the navigation pane.

The Create Campaign page appears.

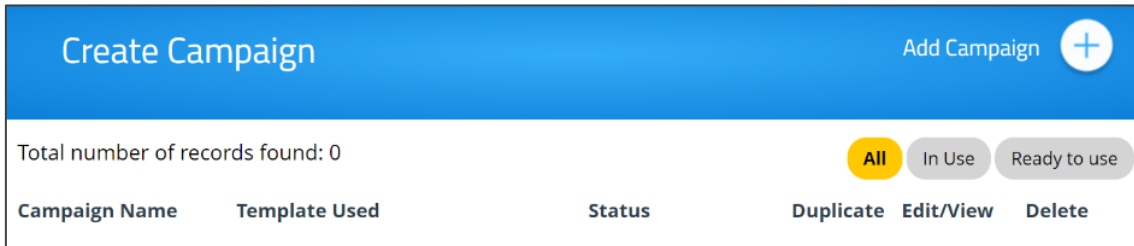

Figure 66: Campaign Editor

2. Click **Add Campaign**; The Campaign Editor appears.

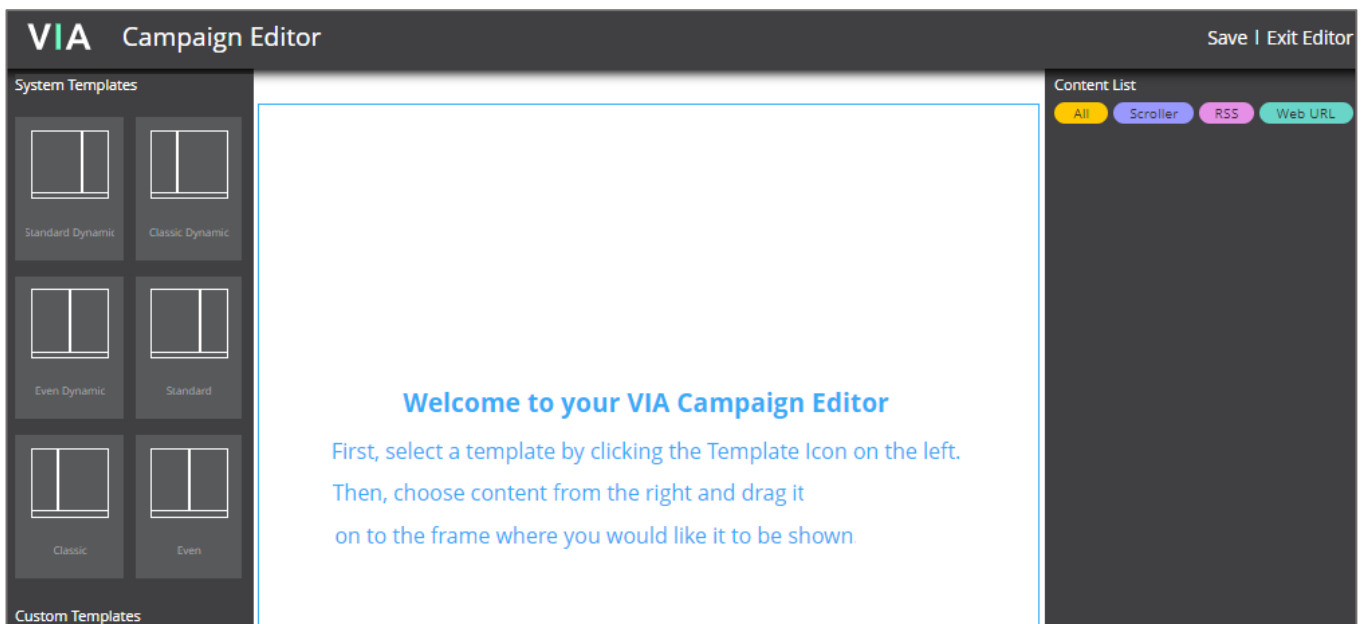

Figure 67: Campaign Editor Pane

3. Click a System or Custom Template; The template appears in the preview box.
4. Click and drag one or more elements from the Content List into each frame. The active frame turns blue, and a list of the content items appears below the preview.
5. Set a Playlength for relevant items of content in the frame.



Videos and other content that have a specific time length do not need to be set.

6. Click **Save**; A message appears.
7. Enter a name for your Campaign and click **Ok**.

The Campaign is configured, and it appears on the Create Campaign page.

Schedule Campaign

VIA Connect² enables you to schedule when a digital signage campaign is displayed.

To schedule a digital signage campaign:

1. Click **Digital Signage > Schedule Campaign** on the navigation pane.

The Schedule Campaign page appears.

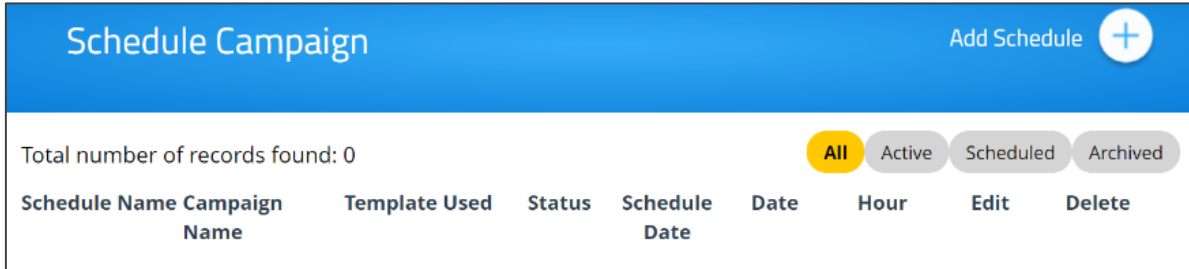

Figure 68: Schedule Campaign Page

2. Click **Add Schedule**.

The Scheduling pane appears.

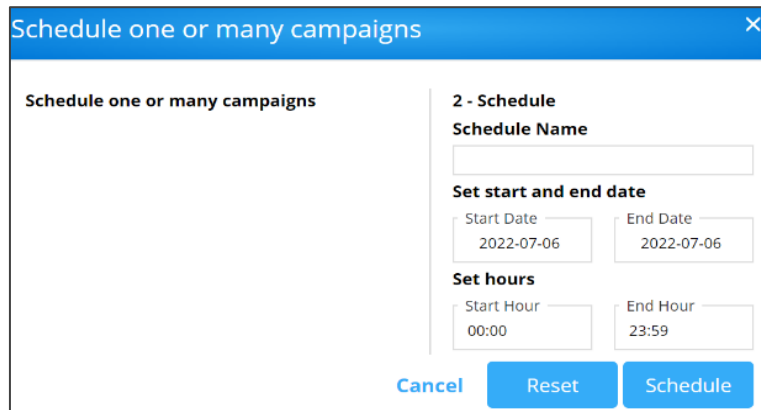

Figure 69: Schedule Pane

3. Select a Campaign to schedule.
4. Set a start date, end date, and hours.
5. Enter a name for the Campaign.
6. Click **Schedule**.

The Campaign is scheduled, and it appears on the Schedule Campaign page.

Font Management

VIA Connect² enables you to add new Fonts for digital signage.

To add new fonts to Digital Signage:

1. Click **Digital Signage > Font Management** on the navigation pane.

The Font Management page appears.

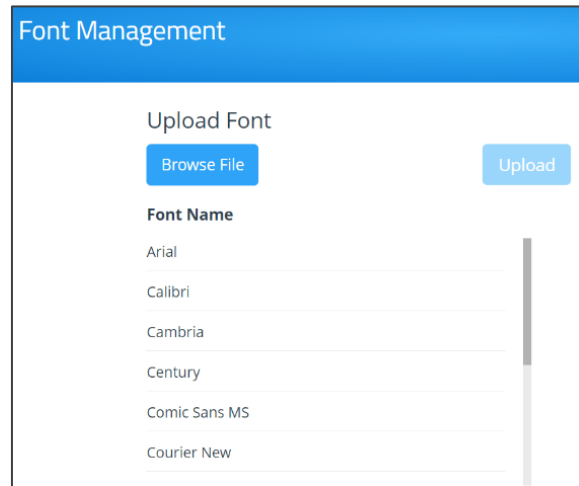

Figure 70: Font Management Page

2. Click **Browse File**.
A file browser appears.
3. Open the relevant font file and click **Upload**.
The new font is installed on VIA Connect² and can be used for Digital Signage.

Reports

VIA Connect² enables you to maintain your VIA unit by performing the following:

- [Viewing and Searching System Activity Logs](#) on page [68](#).
- [Updating Firmware](#) on page [69](#).
- [Activating the VIA Gateway License](#) on page [70](#).
- [Digital Signage License](#) on page [71](#).
- [Resetting Defaults](#) on page [71](#).

Viewing and Searching System Activity Logs

VIA Connect² embedded web pages can log activities such as logins, presentations and VIA feature use to aid in diagnosing problems or tracking participant actions.



To activate system activity logs, see [System](#) on page [39](#).

There are two types of system logs available for viewing and search:

- Gateway Activity Log – Shows activity by meeting participants.
- Webadmin Activity Log – Shows activity of the Gateway and Gateway Settings embedded web pages.

To view and search the system activity logs:

1. Click **Reports > Webadmin Activity Log / Gateway Activity Log** on the navigation pane; The Webadmin Activity Log / Gateway Activity Log page appears.

User Id	Action Taken	Activity Date	Remarks	Host Name
su	Login	2023-01-03 07:02:59	Success	192.168.30.33
su	Login	2023-01-03 10:59:06	Success	192.168.30.33

Figure 71: Web Activity Log Page

2. Select the date range of the log entries to be displayed.
3. Enter a search term and press the Enter key.
The filtered search results appear in the table at the bottom of the page.





Click **Export to PDF** or **Export to CSV** to save a file of the log table on your computer.

Utility

Updating Firmware

VIA Connect² enables you to update your VIA Connect² firmware.

 If you are running a firmware version lower than 2.3, please install the 2.3.0418.960 release before updating your device to the latest release. In this case, use ONLY the .zip file available for download from our technical support web page: www.kramerav.com/support/downloads.asp.

 The upload process and then the unit reboot may take a few minutes.

To update your VIA Connect² firmware:

1. Click **Utility > Update Firmware** on the navigation pane;
The Update Firmware page appears.

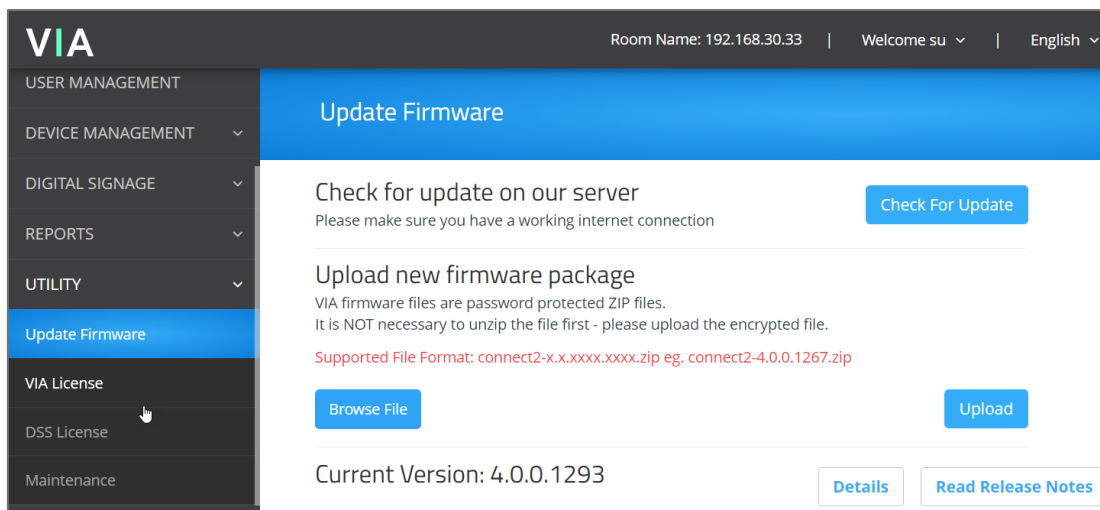



Figure 72: Update Firmware Page

2. When using an update file saved on your computer:
 - a. Click **Browse File**; A file browser appears.
 - b. Select the relevant firmware update file.
 - c. Click **Upload**.
The new firmware is uploaded to the unit and the firmware is updated.
3. When using an update file on the website, and you have an internet connection:
 - a. Click **Check for Update**.
A message appears with information about an available update.

 Check for Updates is also available on the System Information Page.
 - b. If an update is available, confirm the upload.
The new firmware is uploaded to your computer.
 - c. Click **Browse File**; A file browser appears.
 - d. Select the relevant firmware update file.

- e. Click **Upload**.

The new firmware is uploaded to the unit, the FW is updated and the unit reboots.



To verify the update, view the current firmware version on the upper right corner of the User Dashboard's Participants tab.

Activating the VIA Gateway License

To upload your VIA Connect² license:

1. Select **UTILITY > VIA License** on the navigation pane; The VIA License page appears.

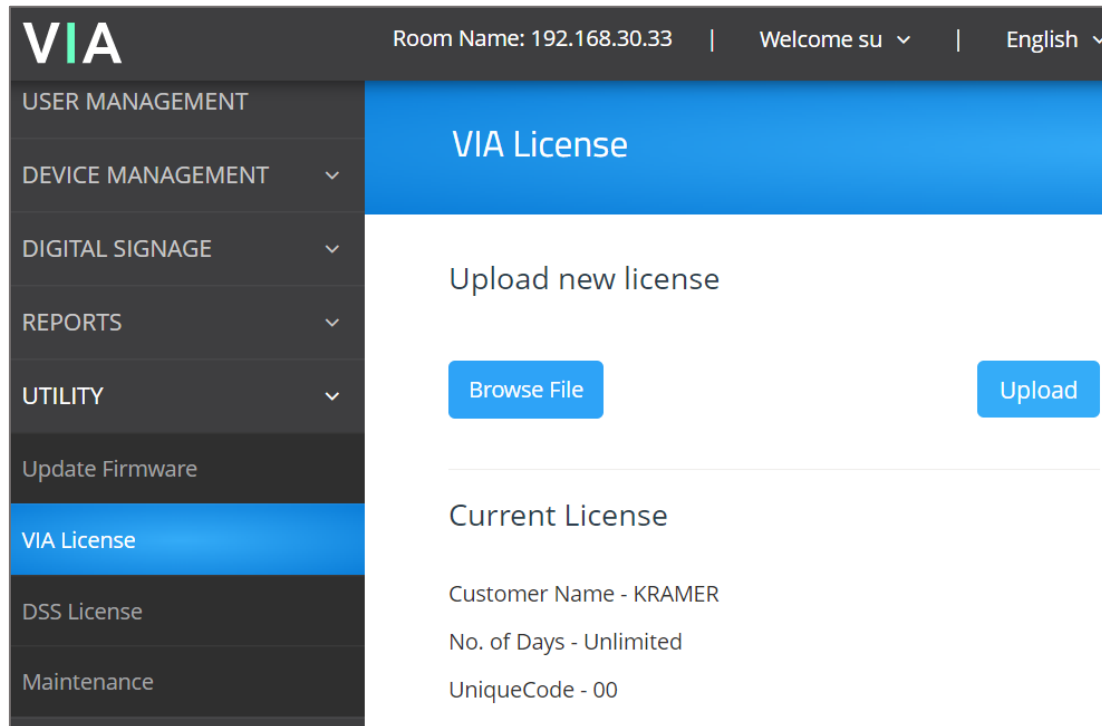

Figure 73: VIA License Page

2. Click **Browse File**; A file browser opens.
3. Select the relevant license file.
4. Click **Upload**.

The license is installed on **VIA Connect²** and license information appears at the bottom of the page.

To Activate your VIA Connect² license:



If a Digital License is already installed on your device, the name of the license appears on the bottom of the page.

1. Select **UTILITY > VIA License** on the navigation pane; The VIA License page appears.
2. Click **Activate License**.

The **VIA Connect²** license is activated, and license information appears at the bottom of the page.

Digital Signage License



VIA Connect² devices have a built-in digital signage license.

Resetting Defaults

VIA Connect² enables you to reset VIA Connect² to factory defaults.



Resetting Calendar Settings removes the calendar settings from the unit and credentials will be required to renew synchronization to your calendar.



Applied changes take effect once the VIA is rebooted or the VIA session is reset.

To reset default settings:

1. Click **Utility > Maintenance** on the navigation pane.
The FACTORY RESET tab in the Maintenance page appears.

Figure 74: Factory Reset Page

2. Select the default configurations you would like to reset from the list or click **Select All** to select all settings.
3. Click **Apply**.
Default settings reset after reboot.

To reset Logs:

1. Click **Utility > Maintenance** on the navigation pane.
The Factory Reset tab on the Maintenance page appears.
2. Select the **Logs** checkbox.

3. Click **Apply**.
Logs resets after reboot.

For Web Administrator: Gateway Dashboard

Administrators control an individual **VIA Connect²** device from two menus:

- **Gateway Management Pages** – These are a web UI, loaded from inside the device, which control general device settings. The Management Pages are high-level controls which can only be accessed over LAN, and require an administrator's password (see [For Web Administrator: Gateway Management Pages](#) on page 13)
- **Gateway Dashboard** – This web UI, also loaded from inside the device, controls features of the meeting interface and is described in this chapter. Depending on local configuration, non-administrators may also be able to change settings.

A **VSM** (VIA Site Manager, optional) may also be used to centrally control all VIA devices.

Logging in to the Gateway Dashboard

The Gateway Dashboard is accessed with a mouse and keyboard connected directly to the VIA gateway unit (see [Collaborating on the Main Display](#) on page 97) or through an external device that is logged in to a meeting and in Collaboration mode (see [Using the Whiteboard](#) on page 98).



- Access to the Gateway Dashboard is controlled by the Quick Client Access setting in the Via Settings > System tab (see [System](#) on page 39).
- If a Moderator is defined, then only the moderator can access this menu.
- The Settings tab requires an administrator user and password. (see [Settings – Logging into the Settings tab](#) on page 74).

Click the VIA icon **VIA** in the lower left of the main display or use CTRL-Tab to view an open screen. The Gateway Dashboard opens on the Features page.

Menu options:

- **Participants** – View a list of participants, see who is presenting, chat, share files. Moderators can force someone to present and stop them from presenting.
- **Features** – Enable and disable the Whiteboard, Screen Sharing, Third Party Apps, control HDMI access and view items saved to the cloud, such as whiteboards or meetings.
- **Settings** – For administrator only – Control network settings, audio connection and enter license details.
- **Power** – Reset the session, reboot or shutdown the VIA device.

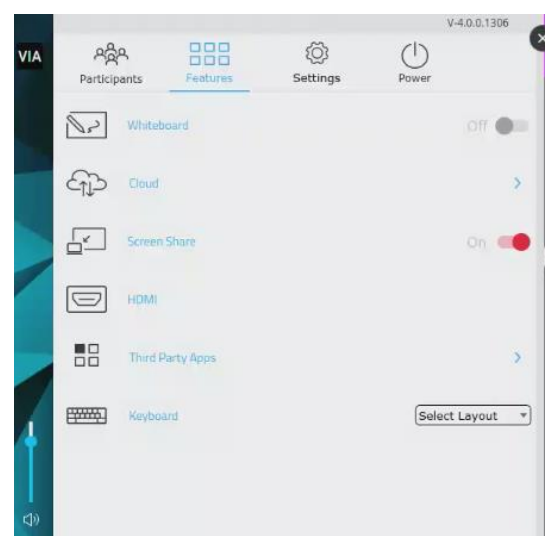

Figure 75: Gateway Dashboard Features Page

Settings – Logging into the Settings tab

To log in to the Gateway Dashboard Settings:

1. Click the VIA icon **VIA** in the lower left of the main display or use CTRL-Tab to view an open screen. The Gateway Dashboard appears.
2. Click **Settings**. The login window appears.
3. Type an administrator username and password (default user name = su, default password = supass).

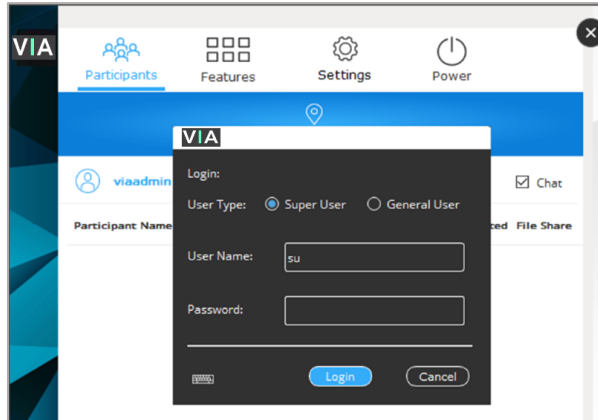

Figure 76: Gateway Dashboard Settings Login Page

The **Settings** page opens on the LAN Settings tab.

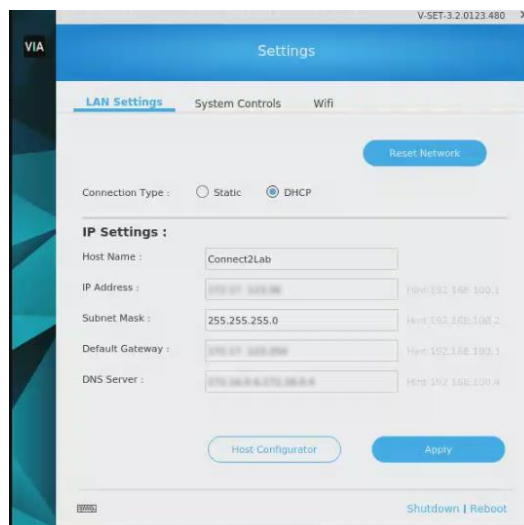

Figure 77: Gateway Dashboard Settings Login Page

LAN Settings



By default, the IP address of your **VIA Connect²** is set automatically by DHCP. See below if you want to set a static IP address.



When changing these settings, please contact your IT administrator. Incorrect values can cause a loss of communication.

To change the IP address of your **VIA Connect²** unit:

1. See [Settings – Logging into the Settings tab](#) on page [74](#).
2. In the **LAN Settings** tab, under Connection Type, select **Static**.
3. Under Network Information, rename the Gateway IP.
4. Click **Apply**; The IP address of your **VIA Connect²** unit is changed.

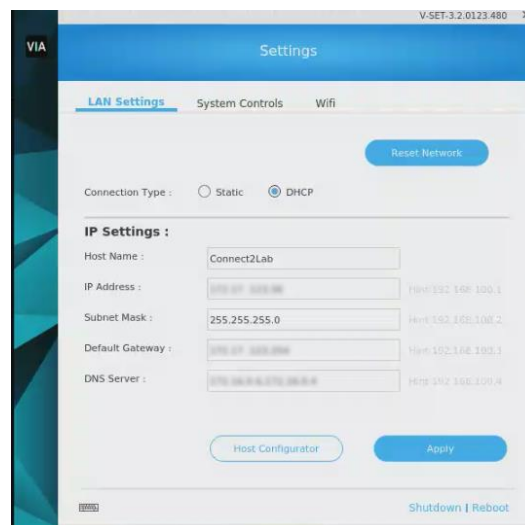

Figure 78: LAN Settings Page

WiFi Settings

VIA Connect² can be setup to use WiFi in two modes: **AP** or **Client**.

- **AP (access point) mode** – Use this option if your device is connected to a LAN. Your VIA Connect² can setup its own WiFi network which can be used by guests to connect to meetings without giving access to the wider network or requiring them to have a network login.
- **Client mode** – Use this option to connect your device to a local network without using a LAN connection.
- **These settings can also be controlled from the Gateway Management Pages.**

To connect to WiFi:

1. See [Settings – Logging into the Settings tab](#) on page 74.
2. Click **WiFi**; The WiFi tab appears.
3. Switch the WiFi on. The switch turns green.

The **Wifi Settings** appear.

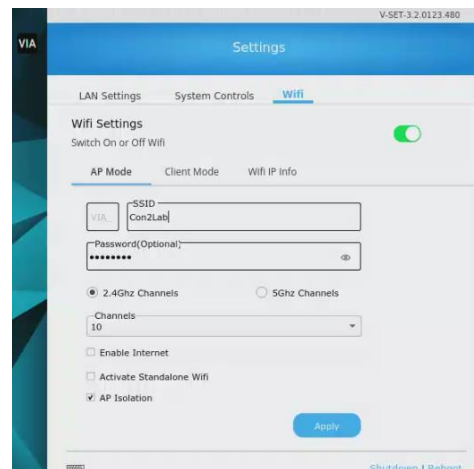



Figure 79: AP Mode tab

WiFi with AP Mode

VIA Connect² can set up a secure access point for users of your VIA Connect² network. This setup is ideal for guest users who you may not want to connect directly to your network.

 In Moderator Mode (see [Moderator Mode](#) on page 47), only the moderator can enable the Access Point.

Setting up secure wireless guest access point:

1. Click **AP Mode** (Access Point Mode) and enter an SSID name and password. AP Mode allows guests to join meetings without needing to login to the corporate/institutional network.
2. Select **Enable Internet** if your VIA Connect² device is connected to a network with internet.
-OR- Select **Activate Standalone Wifi** to create an autonomous network without Internet access.
3. Select **AP Isolation** to prevent Wi-Fi users from connecting to other through the router. Each user gets a private connection that protects them from harm by malicious users.
4. Click **Apply**; The secure wireless guest access point is set up.

WiFi with Client Mode

VIA Connect² enables you to wirelessly connect your VIA Connect² device as a client device to your main network. Use this option if you have no LAN connection available.

To set up Client WiFi mode:

1. See [WiFi Settings](#) on page 76.
2. In the **WiFi** tab, **enable WiFi** (the switch turns green).
3. Click the **Client Mode** tab.

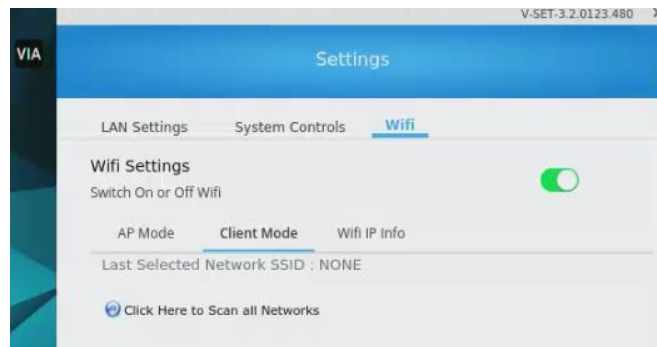

Figure 80: Client Mode tab

4. If you do not see the desired network, click **Click Here to Scan all Networks**.
5. Select a network.
6. Enter the network password and click **Apply**.
7. Disconnect the LAN cable (if connected) and reboot the device.
Client WiFi Mode is set up.

Connecting VIA Connect² to an 802.1X Network

VIA Connect² enables you to wirelessly connect your VIA Connect² device as a client device to an 802.1X network using password authentication or EAP-TLS authentication.

EAP-TLS features include:

- Mutual authentication (server to the client and client to server).
- Key exchange to establish dynamic WEP or TKIP keys.
- Fragmentation and reassembly of very long EAP messages, if needed.
- Fast reconnect via TLS session resumption.

To Connect VIA Connect² as a client device to an 802.1X network:

1. Set up a Radius server to validate the certificate that you will upload to VIA Connect².
2. Set up an access point (AP) with 802.1X type security.



The Radius server IP address and password will be passed while configuring the 802.1x security type on the access point. This password is the same one that is used in the Radius server.

3. Click **Device Management > Network Settings** in the navigation pane.

The Network Settings page appears.

4. Click **WiFi**; The WiFi tab appears.
5. Click the **Switch On or Off Wifi** switch; The switch turns green and the WiFi settings appear.
4. Click **Client Mode**; The Client Mode tab appears.



If you do not see the desired network in the dropdown, click **Click Here to Scan all Networks**.

5. Do one of the following:

- To connect to the network with username and password authentication, select the SSID of the access point that is secured by 802.1X.

Your unit can now connect to the network with a username and password.

-OR-

- To connect to the network with EAP-TLS authentication:
 - f. Select the 802.1X (TLS Certificate) checkbox.

Additional settings appear.

- g. Enter the Identity.
- h. Upload the Authority CA, User Certificate and Key files and click **Apply**.

VIA Connect² automatically reboots and is now connected to the 802.1X network.

Accessing System Controls

Use the Gateway Dashboard to change **VIA Connect²** operating system controls such as audio settings, display settings, and system health. You can also view log files and activate your **VIA Connect²** license.

- ❗ The log folder is only available if system logging is activated in the Gateway Management Pages (see [Viewing and Searching System Activity Logs](#) on page 68).
- ❗ The **VIA Connect²** unit is pre-activated by Kramer. If your license has been revoked, you can activate it here.

To access system controls:

1. See [Settings – Logging into the Settings tab](#) on page 74.
2. On the Gateway Dashboard Settings Screen, click **System Controls**.

The System Controls tab appears.

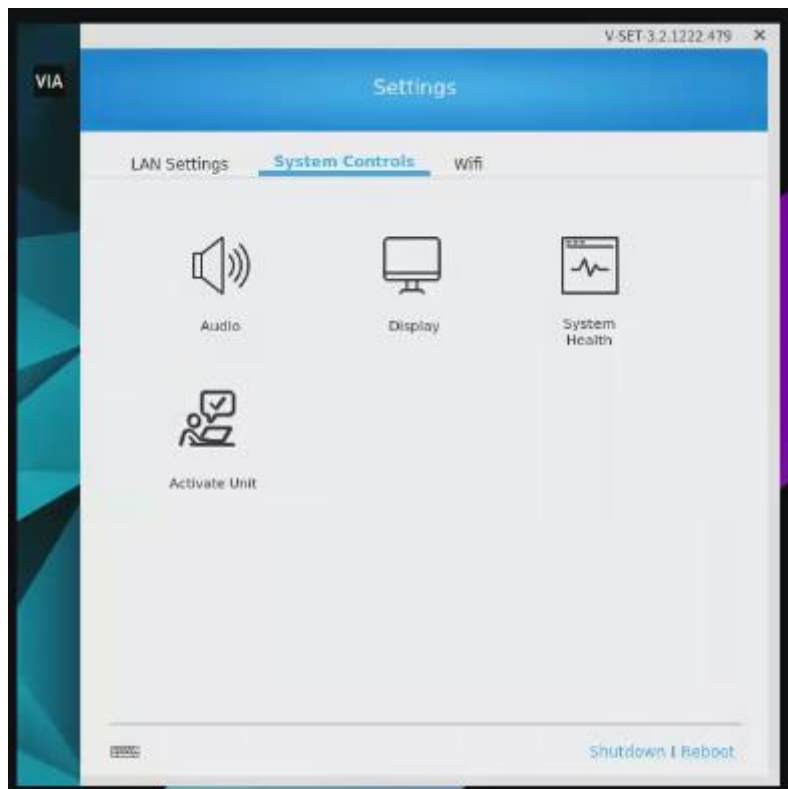

Figure 81: Setting Control Tab

3. Available Options:

- *Audio* – Select audio input and output options: See [Enabling Audio for VIA Versa Video Conferencing](#) on page 80.
- *Display* – View the details of the connected display.
- *System Health* – Check connection statuses (click the Check Status button).
- *Activate Unit* – View or enter the **VIA Connect²** license details.

Enabling Audio for VIA Versa Video Conferencing

VIA Connect² can be connected to a video conferencing device. These instructions enable the audio on the external video conferencing device.

To enable audio from VIA Gateway Dashboard:

1. Connect a video conferencing device to one of the USB connectors of your VIA Connect² and verify that it is powered on.
2. Log in to the VIA Connect² Gateway Dashboard settings (see [Logging in to the Gateway Dashboard](#) on page 73).
3. Click **System Controls**.
The System Controls tab appears.
4. Click **Audio**: The VIA Audio Input/Output Device window appears.

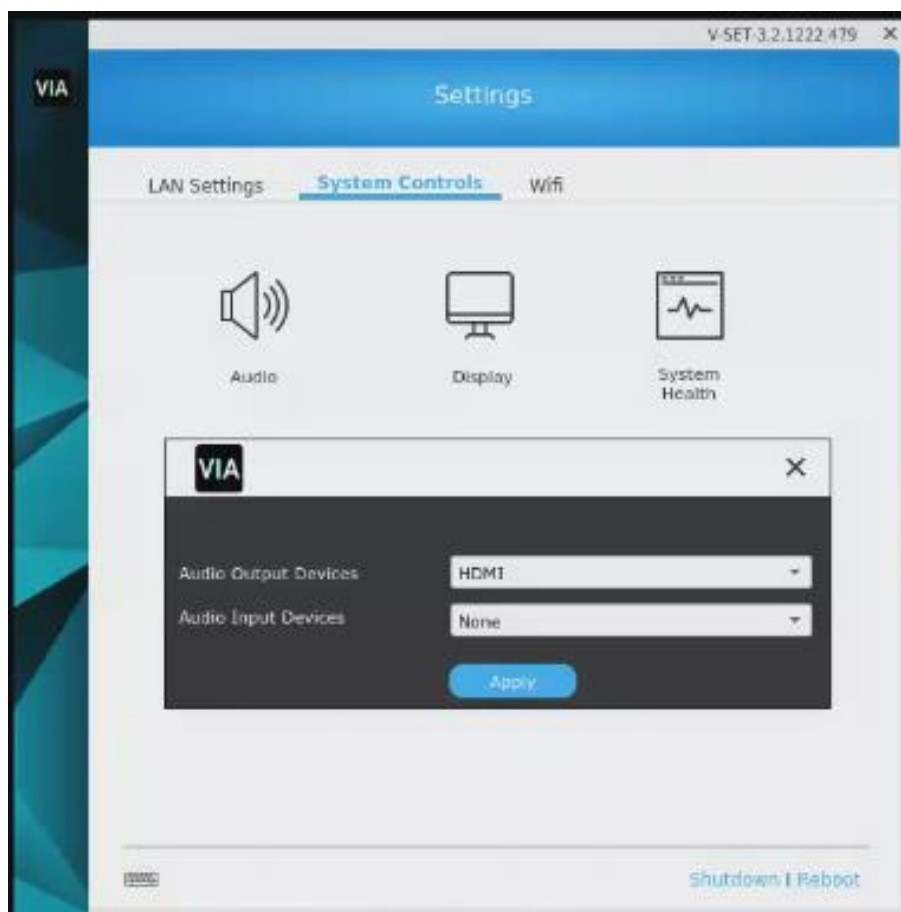

Figure 82: Audio Setting Tab from Gateway Dashboard

5. From the Audio Output Devices drop-down, select **USB**.
6. From the Audio Input Devices drop-down, select the name of the external video conferencing device.
7. Click **Apply**.

Audio is enabled for VIA Versa web-conferencing after resetting the session.

For User: Connecting via VIA Connect²

VIA Connect² enables multiple participants to connect for flexible local and remote on-screen meeting, presenting and collaborating.

You can connect to it from a distance over LAN, locally over WiFi or using an HDMI cable.

Depending on how your system is setup, you can display screens from phones, laptops, Mac Books or other devices, whether connected locally or remotely.

To connect local or remote sources:

- Use an installed or temporary VIA app (the recommended method). See [Installing or Running the VIA app](#) on page [82](#).
- Use a VIA Pad (a preconfigured device) connected to your laptop. [Presenting from a VIA Pad](#) on page [85](#).

To connect local sources only:

- Connect your device to VIA Connect² using an HDMI cable, see [Presenting from an HDMI Source](#) on page [86](#).
- Present by Casting (screen mirroring) to VIA Connect², see [Presenting by Casting \(Screen Mirroring\)](#) on page [86](#).

On Windows devices, presenters can use the Main (communal) display as an additional (extension) screen, see [Presenting with Extended Desktop](#) on page [88](#).

Installing or Running the VIA app

On a Windows PC

1. Make sure you are connected to the same network as the **VIA Connect²** device.
2. If you have no VIA app installed, enter the IP address of the **VIA Connect²** in a browser window: The VIA device loads the Welcome page onto your display:

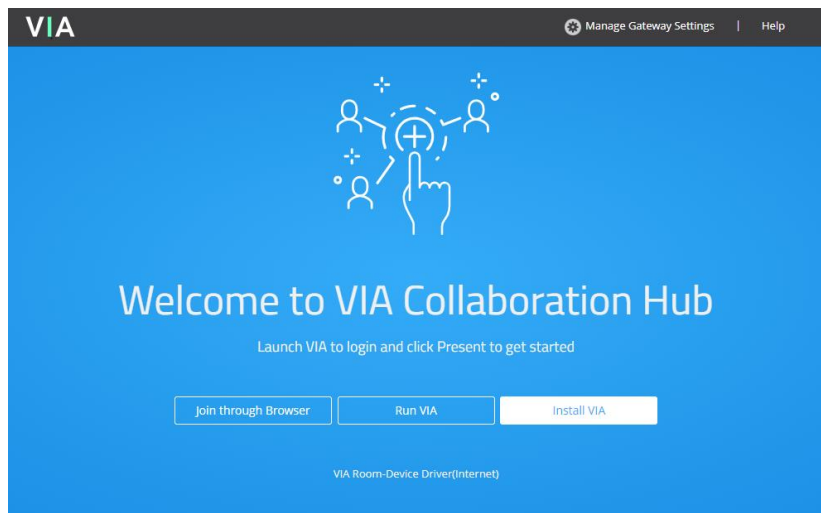

Figure 83: The VIA Collaboration page.

- Select one of the following:
 - **Run VIA** - Downloads a temporary **Kramer VIA** app which you can run without installing to join the meeting.
 - **Install the VIA app** – Install the VIA APP and use it to join meetings and moderate.
 - **Join through Browser** – Run the **VIA Connect²** menu in your browser.
3. Continue with [Joining a Room with the VIA app](#) on page [83](#).

On Android or iOS:

1. Download and install the free **Kramer VIA** app from Apple App Store or Google Play or scan the QR code (if shown).



Figure 84: Android Toolbar

2. Continue with [Joining a Room with the VIA app](#) on page [83](#).

Joining a Room with the VIA app

1. Make sure you are connected to the same network as the **VIA Connect²** device.
2. Open your installed VIA app.
 - If you are using a VIA Pad, see [Presenting from a VIA Pad](#) on page [85](#).
3. In the **Kramer VIA** application, the Room Selection window appears.
4. To change the name used to identify you, click the pencil icon  .

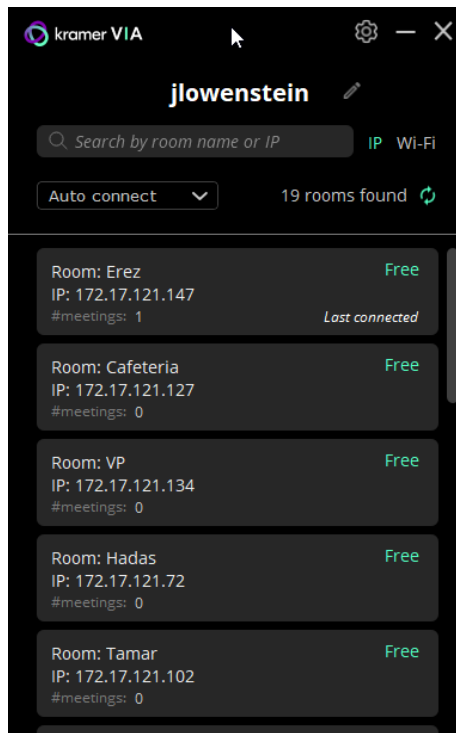



Figure 85: VIA App Window

5. Select a room or enter the IP address of the VIA meeting space you are joining.
6. A pop-up window will request that you enter the **Room Code**.
7. The VIA User Dashboard appears on your device screen: Continue with [Presenting from the VIA User Dashboard](#) on page [84](#).

Presenting from the VIA User Dashboard

 Invite additional users to the meeting (generates an email with a link).

 Leave the meeting.

1. Select what you want to share:

- **Screen** – Share your screen on the Main Display. Click the down arrow “Extend” (Windows only) to add the main display as an extension screen of your laptop, may install a screen driver.
- **App** – Share a window or [third party app](#).
- **Media** – [Share \(stream\) a media file](#). If Media is selected, a list of media is shown to the right of the Share button.
- **HDMI** – Enable/disable sharing over an HDMI connection.

2. Click SHARE:

- The SHARE button becomes the STOP button.
- Your screen, app or media will be displayed on the main display.





3. Interact with participants:

Click the green arrow  to the right of STOP:

- View the participants.
- [Chat and send files](#) to participants.

4. Control what you share:

4 buttons below STOP, green = active.

-  Pause sharing --Your screen freezes on the main display (the VIA app is minimized).
-  Present privately—No one else can present (was “Do Not Disturb”).
-  Maximize your display.
-  Allow remote control – Enable other users to control your device in Collaboration mode.

-  Volume control for shared media.

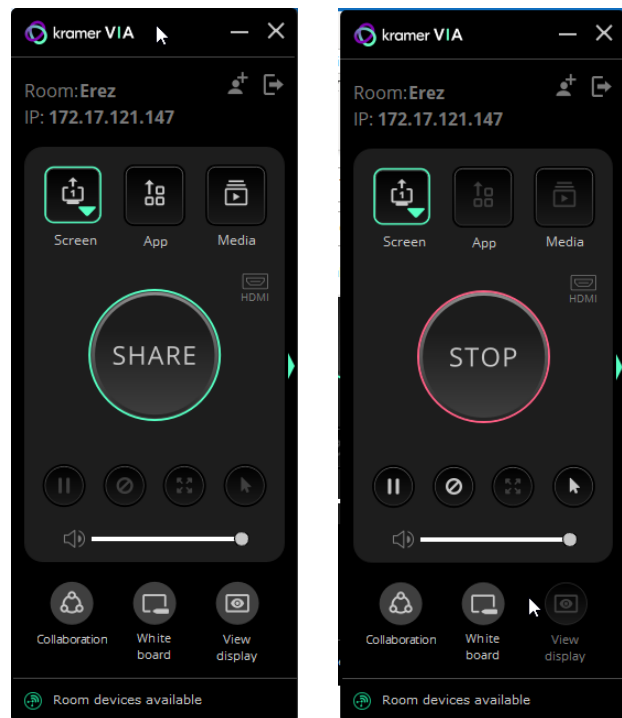

Figure 86: share

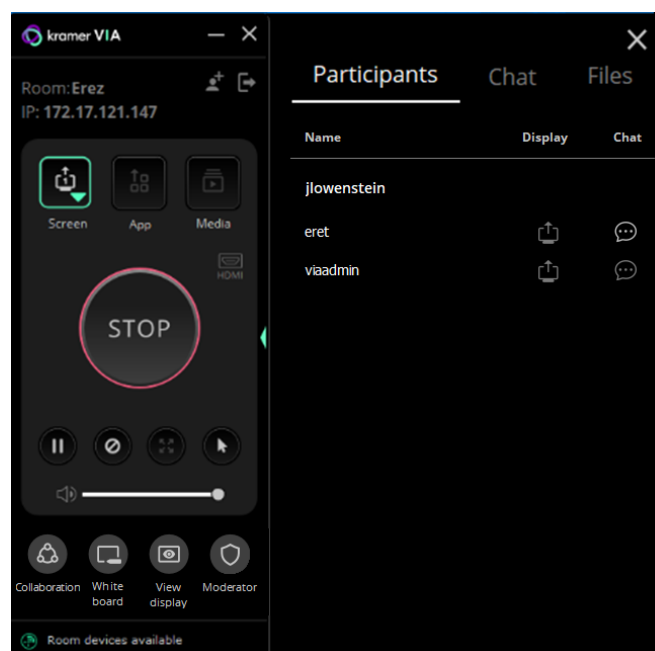







Figure 87: Interacting with Participants

5. Collaborate on the main display:

3 or 4 buttons at the bottom of the User Dashboard

-  **Collaboration** – Adds a [mouse icon with your name](#) on the main display, blue if collaborating.
-  **White board** – Opens [drawing/ annotation controls](#) on the main display, lights blue if active.
-  **View display** – View a copy of the Main Display on your personal device (not if presenting).
-  **Moderator** – Visible if [Moderating](#) is permitted, orange when moderating.

Presenting from a VIA Pad

-  Your **VIA Pad** needs to have been paired with the **VIA Connect²** unit before it is used (see [Configuring VIA Pad Settings](#) on page 22).
-  The following instructions are for Windows and Mac OS users.

To join a meeting using a VIA Pad:



1. Connect your **VIA Pad** to a USB connector on your laptop.
2. Open the **VIA Pad** folder and double-click the **VIA Pad** app. The **Kramer VIA** login window appears.
3. If necessary, type in your room code.
4. Click **Join**.
Your **VIA Pad** lights blue when ready.
The **VIA User Dashboard** and taskbar appear on your device screen.
5. Use **VIA Pad** to present:
 - Press once – Starts presenting or stops presenting your screen on the main display. When you are presenting, the **VIA Pad LED banner** lights green. When you stop presenting, the LED banner lights blue.
 - Press twice while presenting – Freezes or unfreezes your screen. When your screen is frozen, the **VIA Pad LED banner** flashes green.
 - Long press – Displays your screen in full screen mode on the main display, displacing any other participant screen.

Other Presentation Methods

- [Presenting from an HDMI Source](#) on page [86](#).
- [Presenting by Casting \(Screen Mirroring\)](#) on page [86](#).
- [Presenting with Extended Desktop](#) on page [88](#).

Presenting from an HDMI Source

VIA Connect² enables you to show content on the main display from an external device connected to the HDMI IN connector. When a device is connected to the HDMI input, it overrides other VIA Connect² sources.

To show content from an HDMI source:

- Connect the external device to the VIA Connect² HDMI IN Connector (⑥ in [Figure 3](#)).

The external content appears on the main display.



On the VIA User Dashboard, click the HDMI Input icon to toggle between the HDMI input and the VIA meeting input on the main display.



You can also toggle between the HDMI input and the VIA meeting input using the Video Toggle Connector (① in [Figure 3](#)).

Presenting by Casting (Screen Mirroring)

You can use VIA Connect² as a screen mirroring device, without the need to login to a meeting or download any software.

The procedure by which you connect in this way depends on the device you are using:

- Apple laptops and iPhones use **X Airplay Service** - [Presenting with iOS/OS X Airplay Service](#) on page [86](#).
- Windows laptops and Android phones use **Miracast** - [Mirroring Using Miracast](#) on page [87](#).

Presenting with iOS/OS X Airplay Service

All participants in a meeting using an Apple device can mirror their screen on the main display using the Apple AirPlay service. No application is required to activate this mode. However, an administrator must enable the iOS mirroring feature in the VIA Connect² Gateway Management pages (see [Presentation](#) on page [41](#)).

Minimum requirements for mirroring using Airplay services are:

- iPhone or iPad/Mini iPad – Minimum version iOS 10 (iOS 12 or higher is recommended).
- Mac Books and Apple Computers – Minimum version OS X 10.11 (Mojave or higher is recommended).



AirPlay discovery relies on Bonjour (mDNS). For more information see VIA IT Deployment Guide, available for download at: [www.kramerav.com/downloads/VIA_Connect²](http://www.kramerav.com/downloads/VIA_Connect2).

To mirror your screen using AirPlay Services:

1. Connect your Apple device to the network that **VIA Connect²** is connected to.
2. For iPhone or iPad/Mini iPad: Swipe from the upper right corner to reveal the Control Center and click **Screen Mirroring**.

For Mac Books and Apple Computers: Click the AirPlay icon on the Apple Menu Bar, located in the top right corner of the screen, near the clock.

The Screen Mirroring list appears.

3. Select **VIA Connect²**'s AirPlay device name (default = **VIA_AirMirror_XXXX**, where XXXX is a random combination of letters and numbers).
If the room code is enabled, a message appears asking you to enter the code.
4. Type the code that appears on the **VIA Connect²** main display (if activated).
Mirroring starts, and your screen appears on the main display.

To disconnect iPhone or iPad/Mini iPad and stop mirroring:

1. Swipe from the upper right corner to reveal the Control Center.
2. Click **Stop Mirroring**: Mirroring stops.

Mirroring Using Miracast

VIA Connect² enables you to use the native Miracast feature on your Windows 10 laptop or Android device to mirror your screen on the main display.



This feature must be enabled by the Web Administrator (see [Presentation](#) on page [41](#)).



To mirror using **VIA Connect²** you need a Windows 10 laptop or an Android device that supports Miracast.

If the drivers of your Windows10 laptop are up to date and the “Connect to a wireless display” option is not available, your device does not support Miracast.

Android operating system versions 4.2 and higher include built-in Miracast technology. However, some Android 4.2 and 4.3 devices do not support Miracast.

Mirroring Windows 10 Laptops Using Miracast

To mirror a Windows 10 laptop using Miracast:

1. On your Windows laptop, press Windows + K.

The Room Name of your VIA collaboration device appears in the Connect list.

2. Click the Room Name of your VIA device. A PIN code field appears (if Code was activated on your VIA device).



Select the **Allow input from a keyboard...** checkbox to enable another participant to control your laptop from the main display.

3. Enter the Code that appears on the main display and click **Connect**.

The name of your device appears on the main display and then your screen is mirrored on the main display.

Mirroring Android Devices Using Miracast

To mirror an Android device using Miracast:

1. In your Android device settings, open WiFi Direct, Miracast, or ScreenCast.
Device options appear on your screen.
2. Click the Room Name of your VIA collaboration device.
A PIN code field appears (if Code was activated on your VIA device).
3. Enter the Code that appears on the main display and click **Accept/Connect**.
The name of your device appears on the main display and then your screen is mirrored on the main display.

Presenting with Extended Desktop

VIA Connect² can be setup to add the main display as an extension of the user's device desktop. The user's primary screen is not shared, allowing the user to keep their laptop display private while sharing.

 This feature is available on Windows client laptops only, after installation of the required drivers. When using this feature for the first time, the system asks you to install the drivers. Please accept and follow the on-screen instructions. Once the drivers are installed, reboot your PC to enable the feature.

 Mac users can use AirPlay to simulate the same behavior.

To mirror with the Extended Desktop feature:

- On the Kramer VIA User Dashboard, click the Screen-1 icon and select **Extended**.

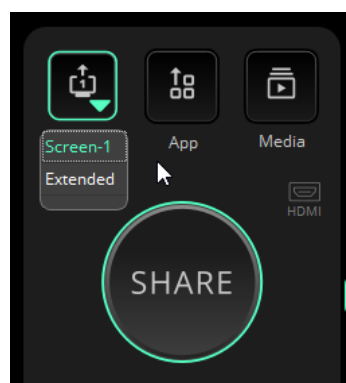



Figure 88: Media Player Window

An extension of your device desktop appears on the VIA main display.

- Drag content to the left and beyond your primary screen to show it on the main display.

 You can change the relative positioning of the two displays in your device Control Panel under Screen Resolution.



Sharing Media from the User Dashboard

Use the Media sharing option on the VIA app to stream video to the main display without sharing your screen. You can also simply share your screen while playing a video.

VIA Connect² also supports direct sharing from VLC player: See [RTSP Streaming Through VLC](#) on page 90 and [RTP Streaming Through VLC](#) on page 94.

Using the Media button

Video can be streamed to the main display at a full HD 1080p/60fps rate.

-  **VIA Connect²** features a 10Mbps maximum video bitrate for 30fps or 60fps videos and handles video files of up to 8GB.
-  The default encoding format is H.264. If your device operating system does not support H.264 encoding, enable JPEG encoding (see [Changing the Default Encoding Format](#) on page 103).

To stream Media:

1. On the User Dashboard, click **Media**.

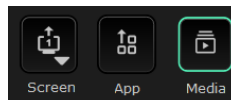

2. The media selection window opens on the right, with 2 tabs:
 - **My Media** tab - Lists videos on your hard drive that you added.
 - **Streaming** tab - Lists URLs of (online) videos that you added.
3. Click **Add+** (bottom right corner) to add more videos.
4. Listed items are available for streaming in future meetings, including in other rooms, not just in the present meeting - Once saved, the stream is listed until you delete it.

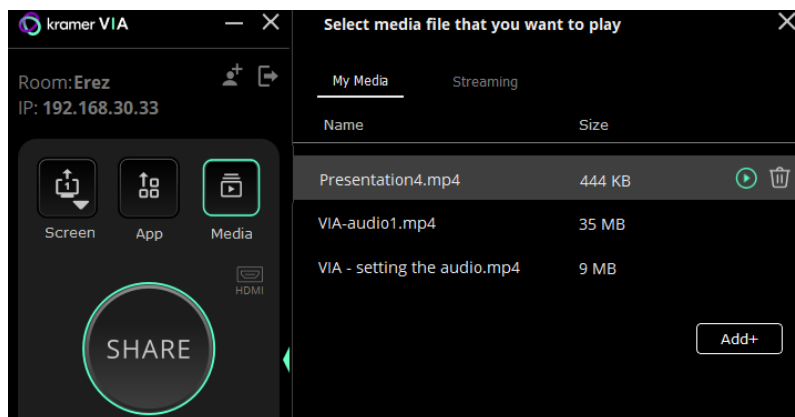



Figure 89: Media Player Window

5. To play an item, select it and click Share / double click it / click the play button.

-  Videos are not stored on the **VIA Connect²**: It handles video playback with the VIA app.
-  Video files shared from your device to the main display by a native media player such as QuickTime and/or Windows Media Player may experience lower frame rates, inconsistent playback, and increased latency, depending on your laptop system's performance.

RTSP Streaming Through VLC

The Real Time Streaming Protocol (RTSP) is a network control protocol designed for use in entertainment and communications systems to control streaming media servers. The protocol establishes and controls media sessions between end points. Clients of media servers issue commands like play and pause, to facilitate real-time control of playback of media files from the server.

VIA Connect² supports RTSP. Media played locally on a computer can be streamed on **VIA Connect²**, provided the computer and **VIA Connect²** are on connected networks.

To Configure RTSP Streaming using VLC Media Player:

1. Open VLC Media Player on your device.

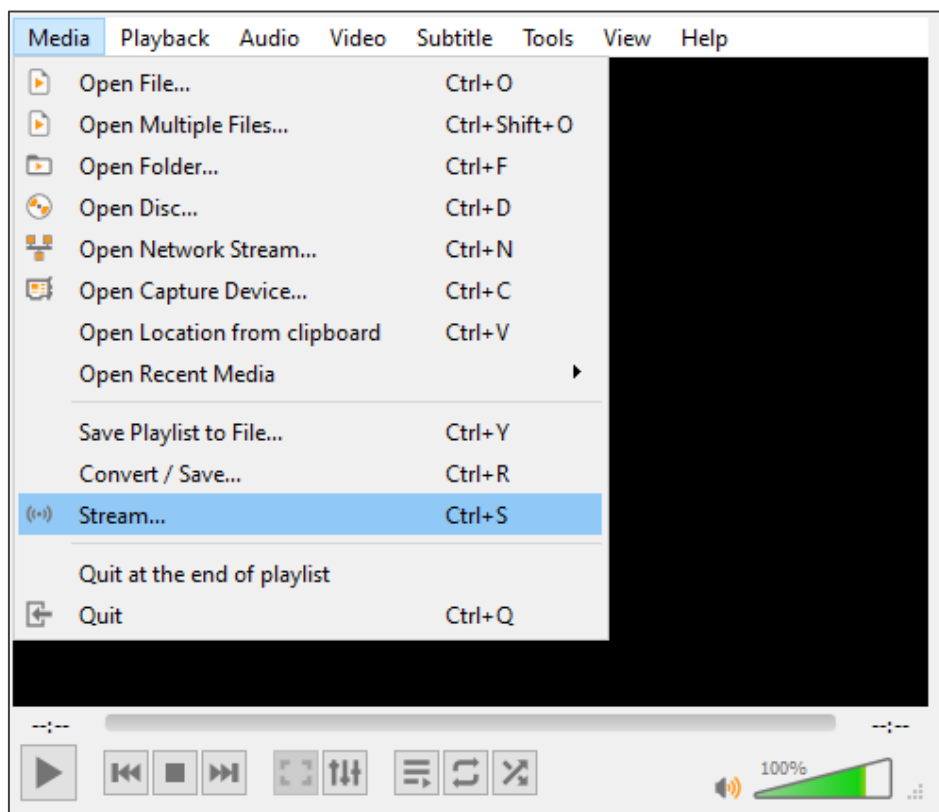

Figure 90: VLC Media Tab

- Click **Media > Stream**.
The Open Media window appears.

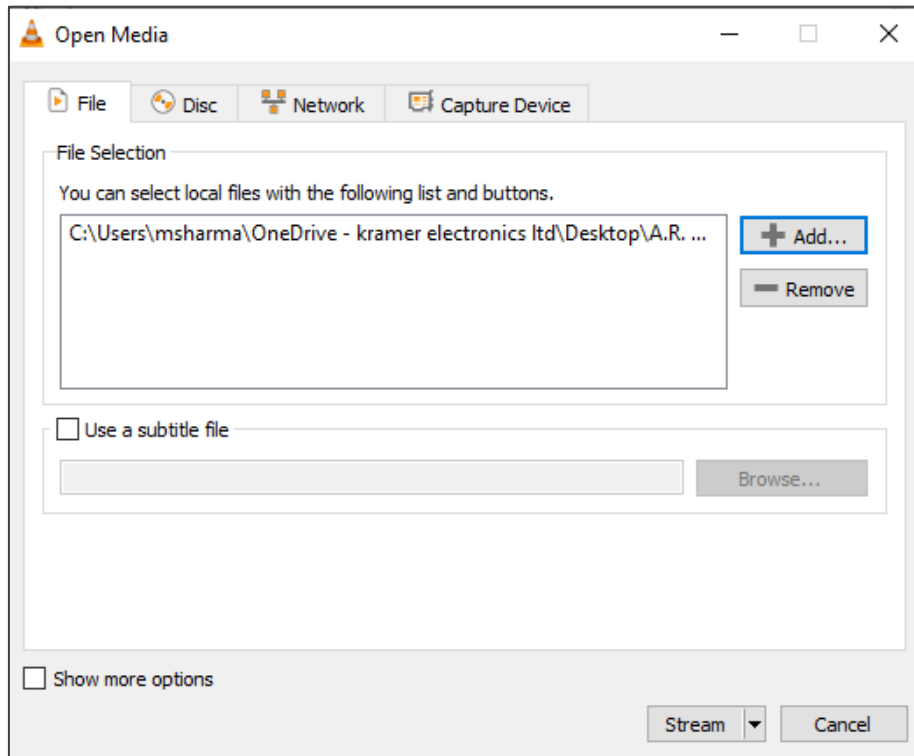

Figure 91: Media Window

- Click **Add** and select a file to stream and click **Stream**.
The Stream Output/Source window appears.

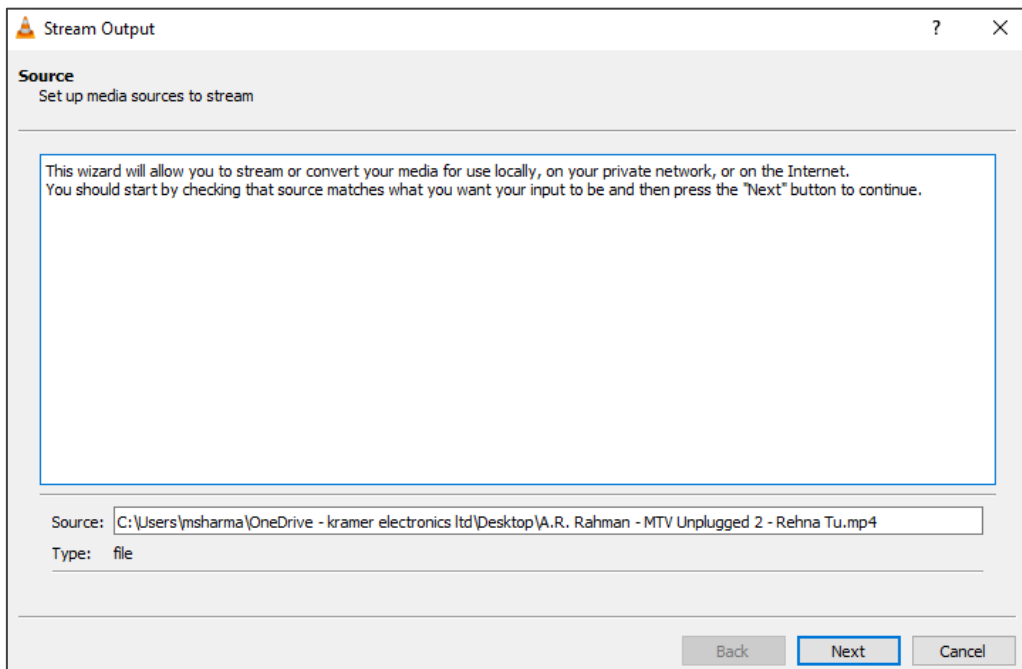

Figure 92: Stream Output Window

4. Click **Next**.

The Stream Output/Destination Setup window appears.

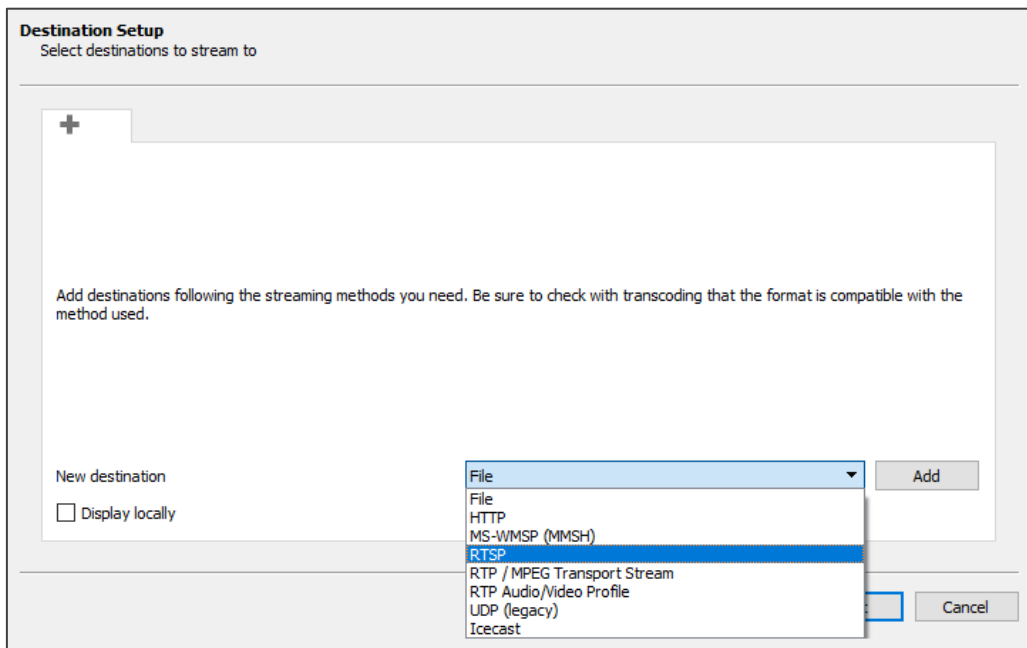

Figure 93: Destination Setup Window

5. Select **RTSP** from the New Destination drop down and click **Add**.

The RTSP tab appears.

6. Type a short name to be used as a Path and click **Next**.

The Stream Output/Transcoding Options window appears.

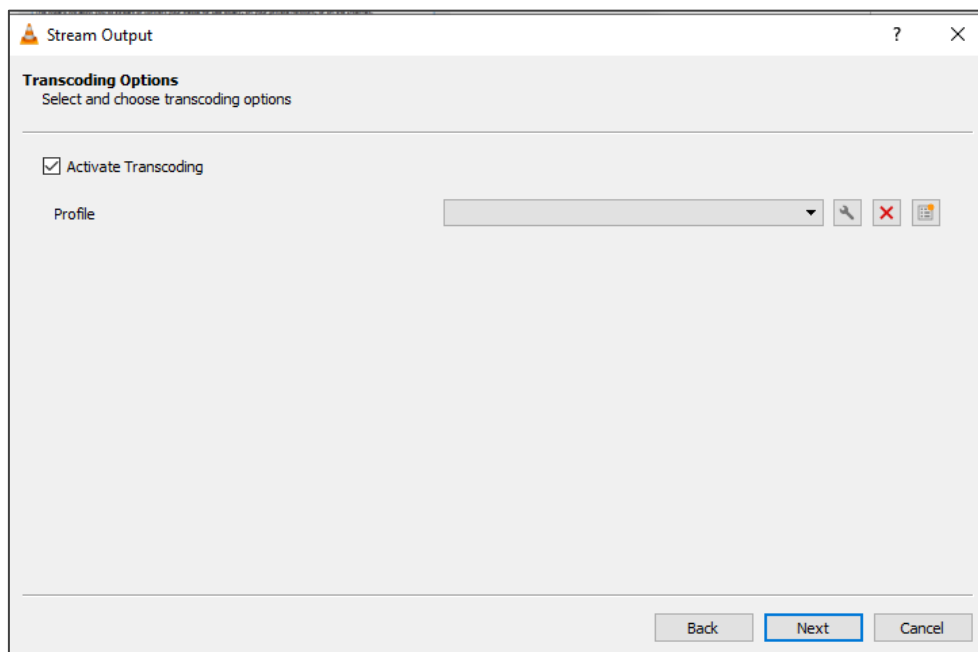

Figure 94: Transcoding Options Window

7. Clear the Activate Transcoding checkbox and click **Next**.

The Stream Output/Option Setup window appears.

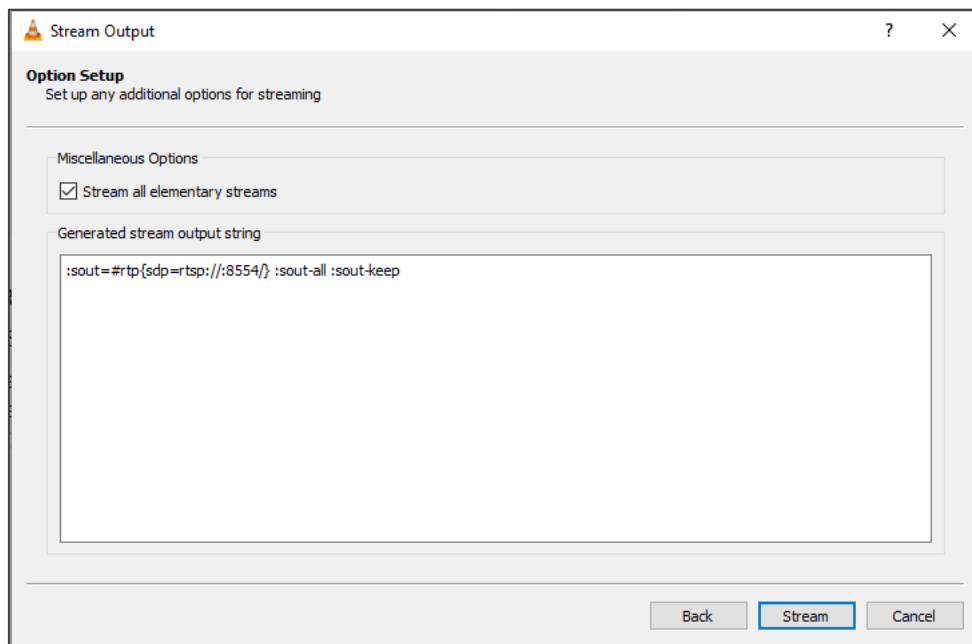

Figure 95: Options Setup Window

8. Select **Stream all elementary streams** and click **Stream**.

9. On the VIA User Dashboard, Select **Multimedia**.

The Multimedia player window appears with the My Media tab open.

10. Click **Streaming**.

The Streaming tab appears.

11. Click **+**.

The URL Name window appears.

12. In the URL Name field, enter a name for the video stream.

13. In the URL path field, enter a URL name in the following format:
rtsp://<local computer IP address>:8554/<name mentioned in step 6>.

14. Click **OK**.

The name and URL of the streaming media appears in the Media list.

15. Select the **RTSP stream** in the Streaming table and click the play button.

RTSP Streaming using VLC Media Player is configured and the media appears on the main display.

RTP Streaming Through VLC

The Real-time Transport Protocol (RTP) is a network protocol for delivering audio and video over IP networks. RTP is used extensively in communication and entertainment systems that involve streaming media, such as telephony, video teleconference applications, television services and Web-based push-to-talk features.

VIA Connect² supports RTP. Media can stream on a **VIA Connect²** unit, provided the computer and **VIA Connect²** are on connected networks.

To stream RTP using VLC:

1. Open VLC.
2. Click **Media > Stream**.
3. Click **Add** and select a file to stream and click **Stream**.
4. Click **Next** on the next screen.
5. Choose RTP/MPEG Transport Stream from the New Destination drop down and click **Add**.
6. Enter **VIA Connect²** unit's IP address and click **Next**.
The Stream Output/Transcoding Options window appears.
7. Clear the Activate Transcoding checkbox and click **Next**.
The Stream Output/Option Setup window appears.
8. Select **Stream all elementary streams** and click **Stream**
9. On the VIA User Dashboard, select **Media**.
10. Click **Add+** and add the URL of the video stream.
11. Select your RTP stream and click the play button.

RTP Streaming using VLC is configured and the streaming video appears on the main display.

Moderating - Controlling the Meeting

VIA Connect² enables any authorized meeting participant to become a moderator. A meeting moderator has control over certain VIA functions that affect other participants, such as:



Moderator Mode must be enabled/disabled by an Administrator in the Gateway Management Pages Device Management > VIA Settings > Moderator Mode. See [Moderator Mode](#) on page 47.

The moderator must access VIA Connect² with a VIA app.

The following Moderator options can be enabled/disabled by the administrator:

- Only certain users can moderate or a password is required to moderate.
- Moderators can enable or disable the chat feature.
- Moderators must confirm the start of a presentation.
- Sessions cannot start until the Moderator is present.

If you can become the moderator, the Moderator icon is shown on your User Dashboard:

1. Click the **Moderator** icon on your User Dashboard to become the moderator.
 - If sessions cannot start without a moderator, the session will start when you click the Moderator icon and end when you click it a second time.
2. The moderator icon turns orange.

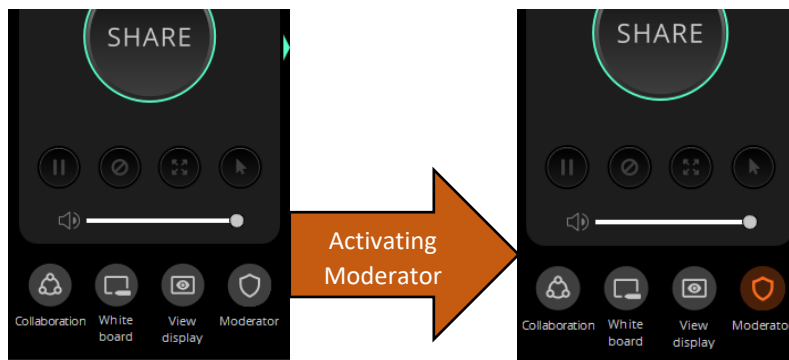

Figure 96: Enabling Moderator mode

3. To stop being moderator, re-click the **Moderator** icon.
4. If the moderator can disable Chat, a checkbox is visible at the top right of the Chat tab.

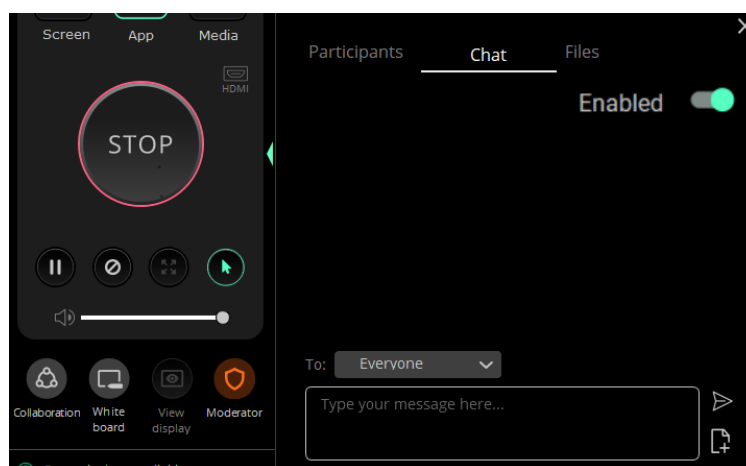

Figure 97: Disabling chat in Moderator mode

- The moderator of a meeting can push a participant's screen onto the main display by clicking the Display icon in the Participants tab of the User Dashboard.

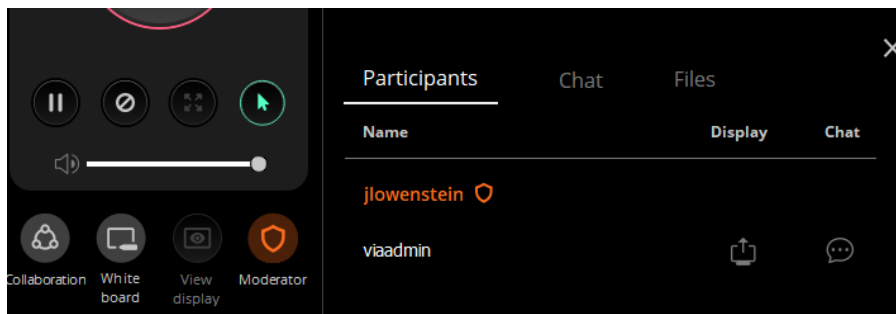

Figure 98: Participants tab in Moderator mode.

- If screen presenting requires moderator permission, then a message will appear on the Moderator's display. A preview of the screen is shown (click the thumbnail to enlarge it).

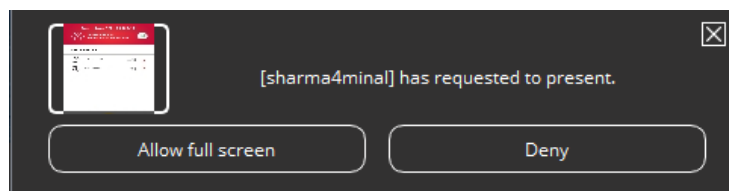

Figure 99: Presentation Request Window

- The moderator** can also end a presentation by clicking on the Display icon in the Participants tab.

Collaborating on the Main Display

VIA Connect² provides state-of-the-art collaboration functionality, enabling meeting participants to interact with content displayed on the main display, annotate shared content, take control of another participants computer and more.

- Up to 254 meeting participants can collaborate.

To collaborate on the main display:

1. On the User Dashboard, click **Collaboration** (someone else can be sharing their screen).
2. The Collaboration icon turns blue.
3. A Stop Collaboration icon appears in the upper right corner of your device screen. Click it to end collaboration.



Figure 100: Collaboration button

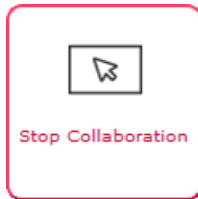

4. Move your cursor up past the top of your device screen and it will appear at the bottom of the main display with your nickname next to it.

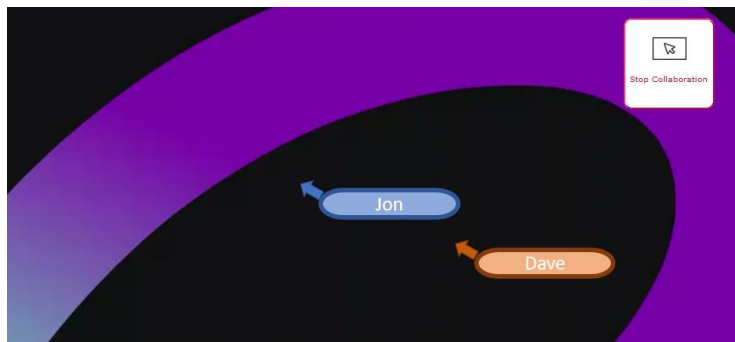



Figure 101: Collaboration Cursors on the Main Display

5. Users in Collaboration mode can control the device shared on the Main Display.
6. Use your cursor as a pointer or operate any of the features from the Main Display and use your keyboard to type text on the Main Display, when necessary.

 To use your cursor to control your own device, move your cursor past the bottom of the main display until it reappears at the top of your device screen.

Using the Whiteboard

The Whiteboard enables VIA Connect² participants to draw on the main display or on a white board. Drawings are temporary but can be saved when collaboration ends.

You can make notes which are not visible to anyone else or draw with other participants.

To start the Whiteboard:

1. On the User Dashboard, click **Whiteboard** (someone else can be sharing their screen).

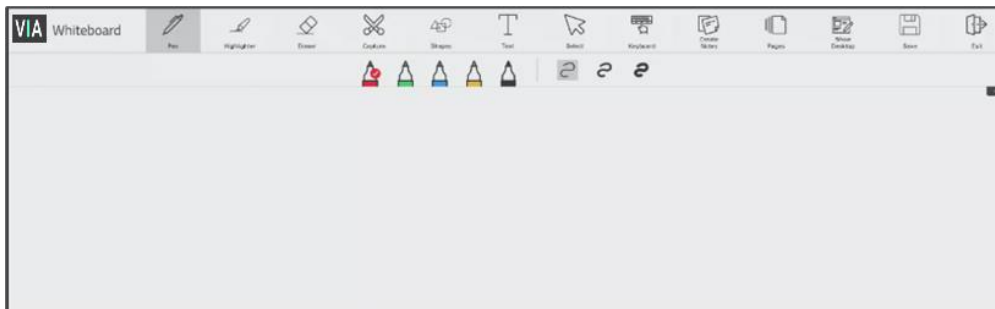

Figure 102: Whiteboard page

2. The whiteboard session starts on the main display and the initiator is put into Collaboration mode.

Whiteboard Tools











Icon	Action
Pen	Draw on the whiteboard.
Highlighter	Highlight text or objects on the whiteboard in yellow.
Eraser	Erase annotations. Click icon corner to select eraser thickness and to erase the entire whiteboard.
Capture	Select an area and paste in onto the current whiteboard page or a new page.
Shapes	Draw a line, rectangle, or circle. Click the lower right corner to select the shape, color and line thickness.
Text	Add a text box. Click the lower right corner to select the font.
Select	Select, drag, resize an annotation, image or text box.
Keyboard	Open a virtual keyboard to insert text into a text box.
Create Notes	Type notes that are attached to the current whiteboard page.
Pages	All content and annotations during a whiteboard session can be saved to VIA Connect ² as one or more pages. Click this icon to view and add pages.
Show desktop	Displays the main display with all running applications. The user can also annotate any content on the main display and add it to a whiteboard page (see Show Desktop on page 99).
Save	Save your activity in either. jpg or. pdf format
Exit	Exit the whiteboard.



The whiteboard toolbar can be moved to the bottom (and back to top) of the display by clicking the small arrows on the right side of the toolbar.

Show Desktop

Show Desktop allows you to hide the whiteboard and to navigate freely on the VIA desktop. A toolbar is available for making annotations on the VIA desktop and capturing an object. For example, capture an area of the screen and add it as an object in the current Whiteboard page.

Icon	Name	Action
	Pencil	Draw on the whiteboard. Click the lower right corner to change the color and the line thickness.
	Highlighter	Highlight text or objects on the main display in yellow.
	Eraser	Erases what you have drawn on the whiteboard. Click the lower right corner to change the eraser thickness.
	Shapes	Draw a line, rectangle, or circle. Click the lower right corner to select the shape, color and line thickness.
	Selection	Select and move an object.
	Window Capture	Capture a screenshot of the active window.
	Area Capture	Click and drag the mouse to capture a rectangular screenshot.
	Save	Save your activity in either. jpg or. pdf format
	Whiteboard	Switch to full screen whiteboard mode.
	Exit	Exit the whiteboard.

Chatting and File Sharing

VIA Connect² enables you to communicate with participants through chat and file sharing.

 Meeting moderators can enable/disable chat (depending on system setup).

To chat or send a file to another meeting participant:

1. Click the green arrow to the right of the SHARE/STOP button.
2. The Participants extension opens.
3. Chatting or sending files from the **Participants** tab:
 - Select a participant and click the speech bubble in their Chat column, this opens the Chat tab with that user's name.

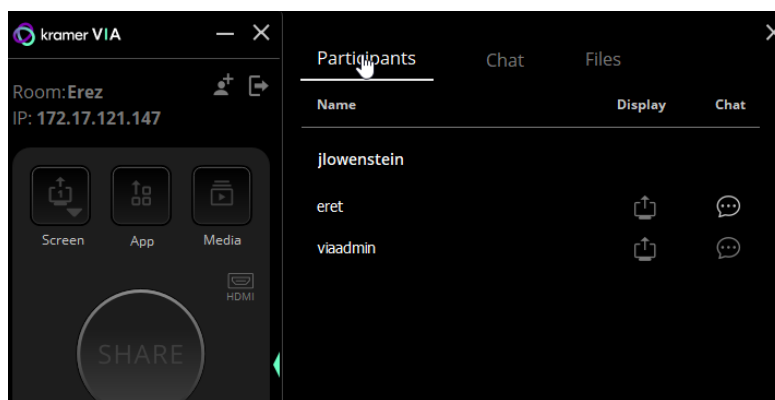



Figure 103: The Participants tab

4. Chatting from the **Chat** tab:

- Click the **Chat** tab (if you are not in it).
- Select the participant you want, (or select “everyone”) and enter the text.
- Click the arrow  to send text or the file  to select and send a file.

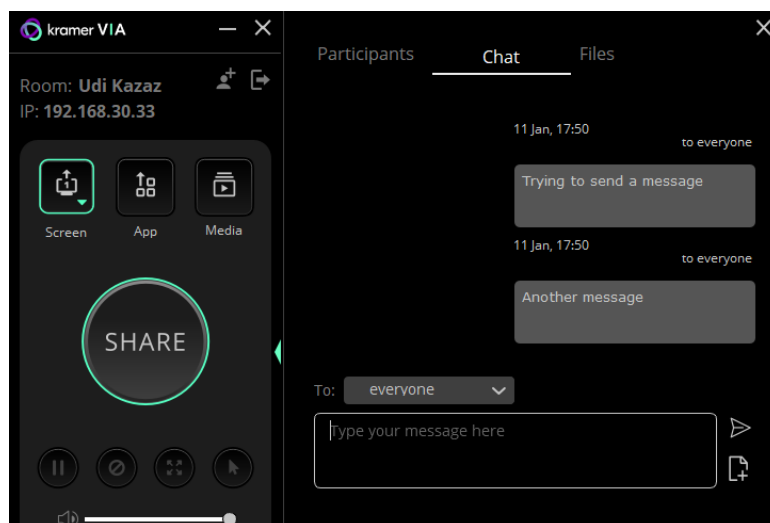



Figure 104: The Chat tab

For User: Advanced Features

Using the Gateway Dashboard

The Gateway Dashboard provides advanced meeting functions that are usually performed by the VIA administrator or a participant with moderator status. The dashboard is a web UI that is loaded from inside the device and controls features of the device's meeting interface. It is activated by connecting a mouse and keyboard directly to the VIA gateway unit's USB ports.

-  To use the Gateway Dashboard **Quick Access Client** must be enabled by an administrator (see [System](#) on page [39](#)).
-  The dashboard can also be controlled by logging in to the meeting in Collaboration mode (see [Using the Whiteboard](#) on page [98](#)).

To use the Gateway Dashboard:

1. Click the VIA logo in the lower left corner of the main display.
The Gateway Dashboard appears (the administrator may disable some settings):

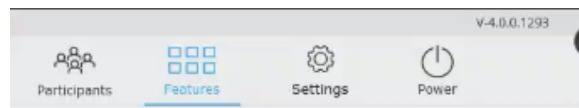

The Gateway Dashboard

The Gateway Dashboard top-menu tabs:

- **Participants** – Shows a list of participants in the current session and allows you to interact with them.
- **Features** – Enables/disables meeting functionality for the participants (see [The Features Menu](#) on page [102](#)).
- **Settings** (requires Administrator privileges) – Controls IP addressing and WiFi accessibility (see [Settings – Logging into the Settings tab](#) on page [74](#)).
- **Power** – Reboots or Shuts down the device.

The Features Menu

The Features Menu has display options that a Moderator or Presenter can display on the main screen and use for the meeting.

- The options available can be changed by an administrator in the Gateway Management pages. See [Connect 2: Features – Configure Client Menus](#) on page 54.



Figure 105: Options on the Features tab

- Screen Share** - Shows the main display on all participant devices. A check mark appears on the Screen Share icon and a new window with a live representation of the main display and a toolbar opens on all the participant's devices. Only participants that are not presenting and/or streaming video will see a copy of the main display.
- Third Party apps** – Opens a list of third party apps for selection. The app appears on the main display and the presenter is put into collaboration mode. The third party app menu can be disabled by the administrator
- Whiteboard** – Opens the whiteboard on the main display for use by the presenter (see [Using the Whiteboard](#) on page 98) .
- Cloud** – Shows a list of meetings and whiteboards saved to the cloud for retrieval.

The Settings Menu

Changing the Default Encoding Format

VIA Connect² enables you to change the default encoding format for your device. This is the encoding format used for presenting and streaming video from your device to **VIA Connect²** to be displayed on the main display. This change affects only your device.



The Web Administrator sets the default encoding format (see [Presentation](#) on page [41](#)).

Two encoding formats are available:

- H. 264 – Default format if your operating system supports H. 264 encoding. This format reduces bandwidth requirements when presenting high-resolution content.
- JPEG – If the operating system does not support H. 264 encoding, enable this format.

To change the default encoding format:

1. In your computer taskbar, click the VIA icon.
The taskbar menu appears.
2. Click **Settings** in the taskbar menu.
The Settings screen appears.
3. Under Presentation Format Encoding, select the required encoding format.
The default encoding format is changed and saved for future sessions.

Monitoring Bandwidth Usage

VIA Connect² enables you to monitor how much bandwidth you are using while communicating with **VIA Connect²**.

To monitor bandwidth usage:

1. In your computer taskbar, click the VIA icon.
The taskbar menu appears.
2. Click **Settings** in the taskbar menu.
The client preferences screen appears.
3. Under Network Monitor Tool, click the **Activate system log and network graph** switch.
Additional controls for the Network Monitoring Tool appear.
4. Click **Open Network Graph**.
The VIA Network Graph window appears. By default, the graph shows live bandwidth usage.
5. Select a date from the Session drop-down to see the graph from another session.
The graph of the session is played back as a video.

Listing Default Meeting Spaces in the Mobile App

When you start **Kramer VIA** mobile app, the Spaces screen appears, showing all meeting spaces that you have favorited. You can set the default screen to show the regular Meeting Spaces screen, which shows all discovered and saved meeting spaces, except for your favorites.

To set the default opening screen to the regular Meeting Spaces screen:

1. On the toolbar at the bottom of the Meeting Spaces screen, tap **Preferences**.

The Preferences screen appears.

2. Select **Spaces**.

The default opening screen changes to Meeting Spaces.

Streaming a Meeting Session

VIA Connect² enables you to stream all activity on the main display during a meeting to other VIA gateway units or computers.

VIA Connect² enables two types of streaming options:

- [Unicast Streaming](#) on page [105](#).
- [Multicast Streaming](#) on page [107](#).

Unicast Streaming

VIA Connect² can stream all main display activity to the following types of receivers:

- Another VIA Unit.
- Computer (Windows, Linux, Mac) which can run VLC player.

Creating a Unicast Streaming URL

To create a unicast streaming URL:

1. Find the IP address of the receiver using one of the following methods:
 - Windows computers – Type ipconfig in the Command Prompt.
 - Mac computers – Type ipconfig in the Terminal.
 - Another VIA unit – Use the room name that appears on the Home screen.
2. Use any allowed port number from 1 – 65536.
3. Use the following format for a UDP URL:

```
udp://<IP address>:<port number>/.
```

Example: For a receiver with an IP address of 192.168.100.123 and an allowed port of 2234, the UDP URL is:

```
udp://192.168.100.123:2234/
```

OR

Use the following format for an RTP URL:

```
<rtp>:<ip>:<port>
```

Feeding Receiver Information to VIA Connect²

The receiver information must be fed to VIA Connect² before streaming can begin.

To feed receiver information to VIA Connect²:

1. In the Streaming tab in the VIA settings template (see [VIA Settings](#) on page [37](#)), paste the receiver URL in the Streaming URL text box. The URL must be in the format explained in [Creating a Unicast Streaming URL](#) on page [105](#).
2. Click the **Streaming** switch ON.
Streaming is activated, and the Streaming URL field is disabled.



To change the receiver URL while streaming, click the **Streaming** switch OFF, paste the new URL in the box and click the **Streaming** switch ON again.

Streaming from one VIA Unit to Another VIA Unit

To stream from one VIA gateway unit (such as **VIA Connect²**) to another VIA unit, you need:

- Two VIA gateway units, one for a receiver and one for a sender.
- One Windows or Mac computer with the latest VIA client application installed.

To stream from one VIA unit to another VIA unit:

1. Connect the two VIA units and the computer to the same network.
2. Use the receiver VIA's room name to create a URL as described in [Creating a Unicast Streaming URL](#) on page [105](#).
3. On the computer, launch the VIA client application and log on to the sender VIA unit.
4. Take moderator rights if Moderator Mode is on.
5. Click the VIA icon in the computer taskbar and select **Start Streaming**.
6. On the computer, log out and log in to the receiver VIA unit.
7. In the User Dashboard, select **Media**.
8. Click Share.
9. Type an easily recognizable URL Name.
10. Type the TCP or UDP URL configured in [Creating a Unicast Streaming URL](#) on page [105](#).
11. Click **Add Media**.
The URL is added to the list.
12. Select the added URL and click **Play**.
Streaming begins from one VIA unit's display to the other VIA unit's display.

Streaming from a VIA Unit to a Windows/Mac Computer

To stream from one VIA gateway unit (such as **VIA Connect²**) to a Windows/Mac computer, you need:

- One VIA gateway unit, for a sender.
- One Windows or Mac computer with the latest VIA client application installed for a receiver.

To stream from one VIA unit to a Windows/Mac computer:

1. Connect the VIA unit and the computer to the same network.
2. Use the receiver computer's IP address to create a URL as described in [Creating a Unicast Streaming URL](#) on page [105](#).
3. Use this URL on the VIA unit's web pages as explained in [Feeding Receiver Information to VIA Connect²](#) on page [105](#).
4. Log in to the VIA client application on the receiver computer.
5. Take moderator rights if Moderator Mode is on.
6. Click the VIA icon in the computer taskbar and select **Start Streaming**.
7. Launch VLC.

8. Click **Media > Open Network Stream**.
9. Type the streaming URL as `udp://@:<port number>`
Streaming begins and is displayed on the receiver computer.

Multicast Streaming

VIA gateway units (such as **VIA Connect²**) can stream their screens as a multicast so that multiple devices can view the gateway's display.

Creating a Multicast URL

To create a Multicast IP URL:

1. Select an IP address in the following range:
224. 0. 0. 0 to 239. 255. 255. 255
2. Select any allowed port number from 1–65536.
3. For example, for an IP address of 224. 0. 0. 5 and an allowed port of 2222, define the UDP URL as: `udp://224. 0. 0. 5:2222/`

Feeding Multicast IP Information to VIA Unit

To feed multicast information to the VIA unit:

1. In the Streaming tab in the VIA settings template (see [VIA Settings](#) on page 37), paste a URL in the Streaming URL text box in the format described in [Creating a Unicast Streaming URL](#) on page 105.
2. Click the Streaming switch ON.
Streaming is activated, and the Streaming URL field is disabled.



To change the receiver URL while streaming, click the **Streaming** switch OFF, paste the new URL in the box and click the **Streaming** switch ON again.

Starting Multicast Stream

1. Launch the VIA client application on a Windows / Mac computer.
2. Make sure the client computer is on the same network as the VIA gateway.
3. Take moderator rights if Moderator Mode is on.
4. Click the VIA icon in this computer's taskbar and select **Start Streaming**.
The Multicast Stream starts.

Receiving a Multicast Stream on Multiple VIA Units

1. Login through the VIA Client to the target VIA unit.
2. On the User Dashboard, select **Media**.
3. Click **Add Media (URL)**.
4. Type the streaming URL as `udp://@<IPAddress>:<port number>`
5. The URL is added to the list.
6. Select the added URL and click **Play**.
Streaming begins from one VIA's display to another VIA Gateway.



Repeat steps 1–6 to stream to another VIA unit.

Receiving Multicast Streams on Multiple Windows/Mac Computers

1. Launch VLC on the client computer.
2. Click **Media > Open Network Stream**.
3. Type the streaming URL as `udp://@<IPAddress>:<port number>`
Streaming starts from the VIA unit to the receiver computer.



Repeat steps 1–3 to stream to another computer.

Connecting a Video Conferencing Device

When you conduct a video conference from your personal device, involving others in the conference room can be limited because you are using the camera and microphone on your device. **VIA Connect²** enables you to switch from using your device camera and microphone to an external video conferencing device connected to **VIA Connect²**, while still running the conference on your device.



For information on enabling the audio for the external video conferencing device, (see [Enabling Audio for VIA Versa Video Conferencing](#) on page [80](#)).

To set up a video conference from your personal device:

1. Run one of the following (available at [www.kramerav.com/product/VIA_Connect²](http://www.kramerav.com/product/VIA_Connect2)) on your device and complete the installation wizard:
 - For Windows OS – **VIAVirtualCamera** Windows Installer .msi file
 - For Mac OS – **VIAVirtualCamera** installer package .pkg file.
2. Join the VIA meeting.
3. Launch a video conferencing app.
4. In the video settings of the video conferencing app select the camera device named **VIA VirtualCam**.
5. In the audio settings of the video conferencing app select the audio device named **VIA Virtual Audio Device**.

The video and audio for the video conference switches to the external video conferencing device and you are ready to start a video.

Technical Specifications

PORTS	1 Ethernet	On an RJ-45 connector
	2 USB 3.0	On a female USB type-A connector
	1 USB 2.0	On a female USB type-A connector
	2 Pin connector	Video Switching control
VIDEO	Max Resolution	Up to 4K@60 for both Input & Output
GENERAL	Processor	Intel® Gemini Lake QC SOC
	Memory	4GB LPDDR4 (2400)
	Storage	32GB eMMC
	Networking	1 x Gigabit LAN WiFi 802.11 ac/b/g/n dual band
	Operating System	Linux
POWER	Input Source	12V DC
	Consumption	1.3A
ENVIRONMENTAL CONDITIONS	Operating Temperature	0° to +40°C (32° to 104°F)
	Storage Temperature	-40° to +70°C (-40° to 158°F)
	Humidity	10% to 90%, RHL non-condensing
REGULATORY COMPLIANCE (STANDARDS COMPLIANCE)	Safety	CE
ENCLOSURE	Type	Aluminum
	Cooling	Fan with sink
ACCESSORIES	Included	Power adapter, Video Switching control cable, VESA mount
DIMENSIONS	Product Dimensions (W x D x H)	7.3cm x 7.3cm x 3.34cm (2.9" x 2.9" x 1.3")
	Product Weight	0.176kg (0.39lbs) approx.
	Shipping Dimensions (W x D x H)	15.2cm x 12cm x 8.5cm (6" x 4.7" x 3.3")
	Shipping Weight	0.581kg (1.3lbs) approx.

VIA App Android Permissions

Permission Category	Description	How Used
Camera	Take pictures and videos.	Logging in through QRCode reader.
Contacts	Find accounts on the device.	Logging in to cloud storage apps like Google Drive, OneDrive, and Dropbox.
Network	<ul style="list-style-type: none"> • Full network access. • View WiFi connection. • View network connection. • Receive internet data. • Phone. 	Accessing the internet over WiFi or mobile data connection and accessing the WiFi name and status for logging in to VIA app.
Location	<ul style="list-style-type: none"> • Access precise location only in the foreground. • Access approximate location (network-based) only in the foreground. 	Same as Network permissions. This is additional permission required in Android 9 and higher.
Storage	Read, modify, or delete the contents of your shared storage.	Acquiring and saving image, video, pdf, and other types of files from the device/SD Card.
Bluetooth Network	<ul style="list-style-type: none"> • Access Bluetooth settings. • Pair with Bluetooth Devices. 	Enabling autofill Nick Name/ Username on the login page, if the device name API is not supported in Android phone.
NFC	Controlling NFC (Near Field Communication).	Logging in via NFC tag.
Power Settings	Prevent phone from sleeping	Preventing your device from going into sleep mode while using VIA App.

The warranty obligations of Kramer Electronics Inc. ("Kramer Electronics") for this product are limited to the terms set forth below:

What is Covered

This limited warranty covers defects in materials and workmanship in this product.

What is Not Covered

This limited warranty does not cover any damage, deterioration or malfunction resulting from any alteration, modification, improper or unreasonable use or maintenance, misuse, abuse, accident, neglect, exposure to excess moisture, fire, improper packing and shipping (such claims must be presented to the carrier), lightning, power surges, or other acts of nature. This limited warranty does not cover any damage, deterioration or malfunction resulting from the installation or removal of this product from any installation, any unauthorized tampering with this product, any repairs attempted by anyone unauthorized by Kramer Electronics to make such repairs, or any other cause which does not relate directly to a defect in materials and/or workmanship of this product. This limited warranty does not cover cartons, equipment enclosures, cables or accessories used in conjunction with this product.

Without limiting any other exclusion herein, Kramer Electronics does not warrant that the product covered hereby, including, without limitation, the technology and/or integrated circuit(s) included in the product, will not become obsolete or that such items are or will remain compatible with any other product or technology with which the product may be used.

How Long this Coverage Lasts

The standard limited warranty for Kramer products is seven (7) years from the date of original purchase, with the following exceptions:

1. All Kramer VIA hardware products are covered by a standard three (3) year warranty for the VIA hardware and a standard three (3) year warranty for firmware and software updates; all Kramer VIA accessories, adapters, tags, and dongles are covered by a standard one (1) year warranty.
2. Kramer fiber optic cables, adapter-size fiber optic extenders, pluggable optical modules, active cables, cable retractors, ring mounted adapters, portable power chargers, Kramer speakers, and Kramer touch panels are covered by a standard one (1) year warranty. Kramer 7-inch touch panels purchased on or after April 1st, 2020 are covered by a standard two (2) year warranty.
3. All Kramer Calibre products, all Kramer Minicom digital signage products, all HighSecLabs products, all streaming, and all wireless products are covered by a standard three (3) year warranty.
4. All Sierra Video MultiViewers are covered by a standard five (5) year warranty.
5. Sierra switchers & control panels are covered by a standard seven (7) year warranty (excluding power supplies and fans that are covered for three (3) years).
6. K-Touch software is covered by a standard one (1) year warranty for software updates.
7. All Kramer passive cables are covered by a lifetime warranty.

Who is Covered

Only the original purchaser of this product is covered under this limited warranty. This limited warranty is not transferable to subsequent purchasers or owners of this product.

What Kramer Electronics Will Do

Kramer Electronics will, at its sole option, provide one of the following three remedies to whatever extent it shall deem necessary to satisfy a proper claim under this limited warranty:

1. Elect to repair or facilitate the repair of any defective parts within a reasonable period of time, free of any charge for the necessary parts and labor to complete the repair and restore this product to its proper operating condition. Kramer Electronics will also pay the shipping costs necessary to return this product once the repair is complete.
2. Replace this product with a direct replacement or with a similar product deemed by Kramer Electronics to perform substantially the same function as the original product. If a direct or similar replacement product is supplied, the original product's end warranty date remains unchanged and is transferred to the replacement product.
3. Issue a refund of the original purchase price less depreciation to be determined based on the age of the product at the time remedy is sought under this limited warranty.

What Kramer Electronics Will Not Do Under This Limited Warranty

If this product is returned to Kramer Electronics or the authorized dealer from which it was purchased or any other party authorized to repair Kramer Electronics products, this product must be insured during shipment, with the insurance and shipping charges prepaid by you. If this product is returned uninsured, you assume all risks of loss or damage during shipment. Kramer Electronics will not be responsible for any costs related to the removal or re-installation of this product from or into any installation. Kramer Electronics will not be responsible for any costs related to any setting up this product, any adjustment of user controls or any programming required for a specific installation of this product.

How to Obtain a Remedy Under This Limited Warranty

To obtain a remedy under this limited warranty, you must contact either the authorized Kramer Electronics reseller from whom you purchased this product or the Kramer Electronics office nearest you. For a list of authorized Kramer Electronics resellers and/or Kramer Electronics authorized service providers, visit our web site at www.kramerav.com or contact the Kramer Electronics office nearest you.

In order to pursue any remedy under this limited warranty, you must possess an original, dated receipt as proof of purchase from an authorized Kramer Electronics reseller. If this product is returned under this limited warranty, a return authorization number, obtained from Kramer Electronics, will be required (RMA number). You may also be directed to an authorized reseller or a person authorized by Kramer Electronics to repair the product.

If it is decided that this product should be returned directly to Kramer Electronics, this product should be properly packed, preferably in the original carton, for shipping. Cartons not bearing a return authorization number will be refused.

Limitation of Liability

THE MAXIMUM LIABILITY OF KRAMER ELECTRONICS UNDER THIS LIMITED WARRANTY SHALL NOT EXCEED THE ACTUAL PURCHASE PRICE PAID FOR THE PRODUCT. TO THE MAXIMUM EXTENT PERMITTED BY LAW, KRAMER ELECTRONICS IS NOT RESPONSIBLE FOR DIRECT, SPECIAL, INCIDENTAL OR CONSEQUENTIAL DAMAGES RESULTING FROM ANY BREACH OF WARRANTY OR CONDITION, OR UNDER ANY OTHER LEGAL THEORY. Some countries, districts or states do not allow the exclusion or limitation of relief, special, incidental, consequential or indirect damages, or the limitation of liability to specified amounts, so the above limitations or exclusions may not apply to you.

Exclusive Remedy

TO THE MAXIMUM EXTENT PERMITTED BY LAW, THIS LIMITED WARRANTY AND THE REMEDIES SET FORTH ABOVE ARE EXCLUSIVE AND IN LIEU OF ALL OTHER WARRANTIES, REMEDIES AND CONDITIONS, WHETHER ORAL OR WRITTEN, EXPRESS OR IMPLIED. TO THE MAXIMUM EXTENT PERMITTED BY LAW, KRAMER ELECTRONICS SPECIFICALLY DISCLAIMS ANY AND ALL IMPLIED WARRANTIES, INCLUDING, WITHOUT LIMITATION, WARRANTIES OF MERCHANTABILITY AND FITNESS FOR A PARTICULAR PURPOSE. IF KRAMER ELECTRONICS CANNOT LAWFULLY DISCLAIM OR EXCLUDE IMPLIED WARRANTIES UNDER APPLICABLE LAW, THEN ALL IMPLIED WARRANTIES COVERING THIS PRODUCT, INCLUDING WARRANTIES OF MERCHANTABILITY AND FITNESS FOR A PARTICULAR PURPOSE, SHALL APPLY TO THIS PRODUCT AS PROVIDED UNDER APPLICABLE LAW. IF ANY PRODUCT TO WHICH THIS LIMITED WARRANTY APPLIES IS A "CONSUMER PRODUCT" UNDER THE MAGNUSON-MOSS WARRANTY ACT (15 U.S.C.A. §2301, ET SEQ.) OR OTHER APPLICABLE LAW, THE FOREGOING DISCLAIMER OF IMPLIED WARRANTIES SHALL NOT APPLY TO YOU, AND ALL IMPLIED WARRANTIES ON THIS PRODUCT, INCLUDING WARRANTIES OF MERCHANTABILITY AND FITNESS FOR THE PARTICULAR PURPOSE, SHALL APPLY AS PROVIDED UNDER APPLICABLE LAW.

Other Conditions

This limited warranty gives you specific legal rights, and you may have other rights which vary from country to country or state to state.

This limited warranty is void if (i) the label bearing the serial number of this product has been removed or defaced, (ii) the product is not distributed by Kramer Electronics or (iii) this product is not purchased from an authorized Kramer Electronics reseller. If you are unsure whether a reseller is an authorized Kramer Electronics reseller, visit our web site at www.kramerav.com or contact a Kramer Electronics office from the list at the end of this document.

Your rights under this limited warranty are not diminished if you do not complete and return the product registration form or complete and submit the online product registration form. Kramer Electronics thanks you for purchasing a Kramer Electronics product. We hope it will give you years of satisfaction.



HDMI™
HIGH-DEFINITION MULTIMEDIA INTERFACE



P/N: 2900-301433

Rev: 1



SAFETY WARNING

Disconnect the unit from the power supply before opening and servicing

For the latest information on our products and a list of Kramer distributors, visit our website where updates to this user manual may be found.

We welcome your questions, comments, and feedback.

The terms HDMI, HDMI High-Definition Multimedia Interface, and the HDMI Logo are trademarks or registered trademarks of HDMI Licensing Administrator, Inc. All brand names, product names, and trademarks are the property of their respective owners.