

iCam P30

4K60 PTZ Conference Camera

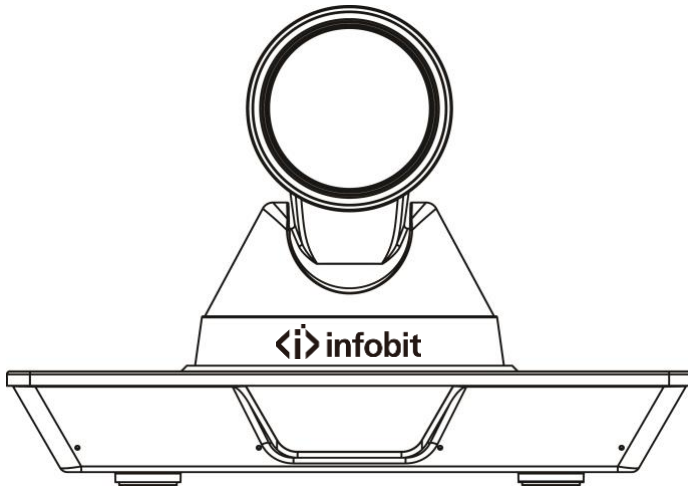

User Manual

English (V1.0)

Catalogue

1	Note.....	1
2	Packing List.....	1
3	Quick Start	1
4	About Product	3
4.1	Features.....	3
4.2	Product Specification	3
4.3	Interfaces and Buttons.....	5
4.4	Dimension.....	5
4.5	Remote Control	6
4.6	RS232 Interface	7
4.7	Serial Communication Control.....	7
5	GUI Settings.....	8
5.1	MENU	8
5.2	EXPOSURE.....	8
5.3	COLOR	9
5.4	IMAGE	10
5.5	P/T/Z	10
5.6	NOISE REDUCTION	11
5.7	SETUP	11
5.8	COMMUNICATION SETUP.....	12
5.9	RESTORE DEFAULT.....	12
6	Network Function	13
6.1	Operating Environment.....	13
6.2	Equipment Installation.....	13
6.3	Internet Connection.....	13
6.4	Camera Controlled by LAN.....	13
6.4.1	Setup IP Address	13
6.4.2	Visit/Access Camera	14
6.5	Camera Controlled by WAN	15
6.5.1	Setup IP Controlled by Dynamic DNS	15

6.5.2	Dynamic DNS Visit Camera	15
6.5.3	VLC Stream Media Player Monitor	15
6.6	Camera Parameter Setup.....	16
6.6.1	Homepage Introduction	16
6.6.2	Video Settings.....	18
6.6.3	Image Settings.....	19
6.6.4	Audio Settings.....	19
6.6.5	System Settings	20
6.6.6	Network Settings.....	20
6.6.7	Device Information	21
6.7	Download the Upgrade Program.....	21
7	Maintenance and Troubleshooting	21

1 Note

● Electric Safety

Installation and operation must accord with electric safety standard.

● Use Caution to Transport

Avoid stress, vibration or soakage in transport, storage and installation.

● Polarity of Power Supply

The power supply of this product is +12V, the max electrical current is 2A. Polarity of the power supply plug drawing shows as below.



● Installation Precautions

Do not grasp the camera lens when carrying it. Don't touch camera lens by hand. Mechanical damage may be caused by doing so.

Do not use in corrosive liquid, gas or solid

environment to avoid any cover (plastic material) damage. Make sure there is no obstacle within rotation range.

Please never power on before installation is completed.

● Do not Dismantle the Camera

We are not responsible for any unauthorized modification or dismantling.



Specific frequencies of electromagnetic field may affect the image of the camera!

2 Packing List

Name	Quantity
Camera	1
Power Adaptor	1
Power Cable	1
RS232 Cable	1
Remote Control	1
Lens Protective Cap	1
3P Phoenix Head	1
User Manual	1

3 Quick Start

1) Please check connections are correct before starting.

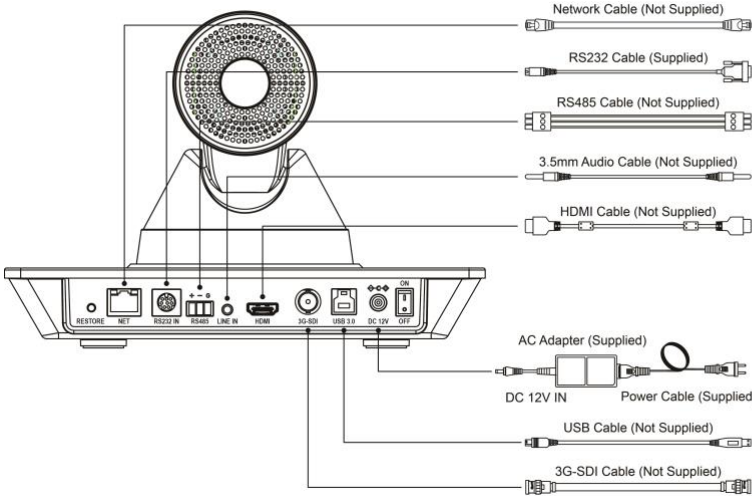

Computer, TV, VCR with audio input jack, Routers or Switches, Speaker Microphone, etc.

- 2) Connect the power adapter to the power connector on the rear panel of the camera. The power indicator on the front panel of the camera is on.
- 3) After the camera is powered on, it starts to initialize, right up to the limit position, and then both horizontal and vertical go to the middle position, the motor stops running, and the initialization is completed.
(Note: If preset 0 is saved, PTZ will be move to preset 0)

4 About Product

4.1 Features

- **4K Ultra HD**

Using a new generation of SONY 1/2.5 inch, 8.51 million pixel high-quality UHD CMOS sensor. It can provide 4K ultra high definition, up to 4K@60fps image coding output, and downwards compatibility with 1080P, 720P resolution.

- **12x Wide Angle Lens**

Customized high quality real 8 million ultra high resolution 4K lens, 12x optical zoom, maximum 71° viewing angle.

- **HDMI 2.0**

It supports HDMI 2.0 version, and can output uncompressed 4KP60 original video.

- **Multiple Interfaces**

It supports NET/HDMI/3G-SDI/USB Interface, and it can output 4 channels of high-definition digital signals at the same time.

- **Low Light**

The application of 2D and 3D noise reduction algorithm greatly reduces image noise. Even under the condition of ultra-low illumination, it still keep the picture clean and clear, and the SNR of image is as high as 55dB.

- **Remote Control**

Through the RS232 IN serial port, the camera

can be controlled remotely.

4.2 Product Specification

Name	4K Video Conference Camera
Camera	
Video System	4K@60fps, 4K@50fps, 4K@30fps, 4K@25fps, 4K@59.94fps, 4K@29.97fps, 1080P@60fps, 1080P@50fps, 1080I@60fps, 1080I@50fps, 1080P@30fps, 1080P@25fps, 1080P@59.94fps, 1080I@59.94fps, 1080P@29.97fps, 720P@60fps, 720P@59.94fps
Sensor	1/2.5 inch, CMOS, Max Effective Pixel: 8.51M
Scanning Mode	Progressive
Lens	12x, f = 4.4mm ~ 52.8mm, F1.8 ~ F2.6
Digital Zoom	16x
Minimum Illumination	0.5 Lux @ (F1.8, AGC ON)
Shutter	1/30s ~ 1/10000s
White Balance	Auto, Indoor, Outdoor, One Push, Manual, VAR
Backlight Compensation	Support
Digital Noise Reduction	2D & 3D Digital Noise Reduction
Signal Noise Ratio	≥55dB
Horizontal Angle of View	71° ~ 8.2°
Vertical Angle of View	42.7° ~ 4.5°
Horizontal Rotation Range	±170°
Vertical Rotation Range	±30°

Pan Speed Range	1.6°/s ~ 76°/s
Tilt Speed Range	0.5°/s ~ 15°/s
H & V Flip	Support
Image Freeze	Support
Number of Preset	255
Preset Accuracy	0.1°

USB Features

Operate System	Windows 7, Windows 8, Windows 10, Mac OS X, Linux, Android
Color System / Compression	YUY2 / MJPEG / H.264 / H.265
Video Format	<ul style="list-style-type: none"> ● YUY2: max to 1080P@30fps ● H.264 AVC/SVC: max to 2160P@60fps ● MJPEG: max to 2160P@30fps
USB Audio	Support
USB Video Communication Protocol	UVC 1.1~1.5
UVC PTZ	Support

Network Features

Video Compression	H.264/H.265/MJPEG
Video Stream	First Stream, Second Stream
First Stream Resolution	3840x2160, 1920x1080, 1280x720, 1024x576, 960x540, 640x480, 640x360
Second Stream Resolution	1280x720, 1024x576, 720x576 (50Hz support), 720x480 (60Hz support), 720x408, 640x360, 480x270, 320x240, 320x180
Video Bit Rate	32Kbps ~ 51200Kbps
Bit Rate Type	Variable Rate, Fixed Rate
Frame Rate	50Hz: 1fps ~ 50fps, 60Hz: 1fps ~ 60fps

Audio Compression	AAC
Audio Bit Rate	96K, 128K, 256K
Protocols	TCP/IP, HTTP, RTSP, RTMP/RTMPS, ONVIF, DHCP, SRT, Multicast

Input/Output Interface

Network Interface	1 x RJ45: 10/100/1000M Adaptive Ethernet Port
Communication Interface	1 x RS232 IN: 8pin Min DIN, Max Distance: 30m, Protocol: VISCA / Pelco-D / Pelco-P 1 x RS485: 3pin phoenix port, Max Distance: 1200m, Protocol: VISCA / Pelco-D / Pelco-P
Audio Interface	1 x LINE IN: 3.5mm Audio Interface
HDMI Interface	1 x HDMI: Version 2.0
3G-SDI Interface	1 x 3G-SDI: BNC type, 800mVp-p, 75Ω. Along to SMPTE 424M standard
USB Interface	1 x USB 3.0: Up to 4K@60fps compressed video and 1080P original video can be output
Power Jack	JEITA type (DC IN 12V)

Physical Parameter

Input Voltage	DC 12V
Current Consumption	1.0A (Max)
Operating Temperature	-10°C ~ 40°C
Storage Temperature	-40°C ~ 60°C
Power Consumption	12W (Max)
MTBF	> 30000h
Size	238 x 131.8 x 166.35mm
Net Weight	About 1.3Kg

4.3 Interfaces and Buttons

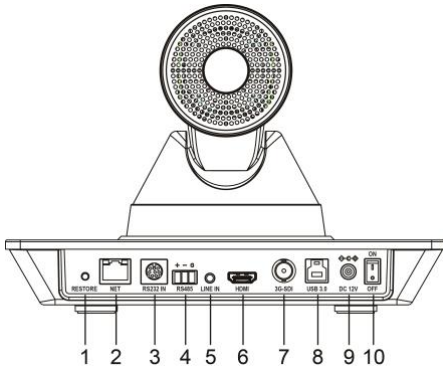

Item	Name
1	Restore Button
2	Network Interface
3	RS232 IN Interface
4	RS485 Interface
5	LINE IN Interface
6	HDMI Interface
7	3G-SDI Interface
8	USB 3.0 Interface
9	DC 12V Interface
10	Power Switch

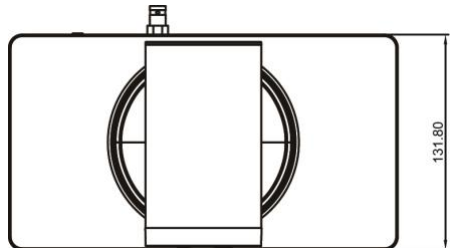
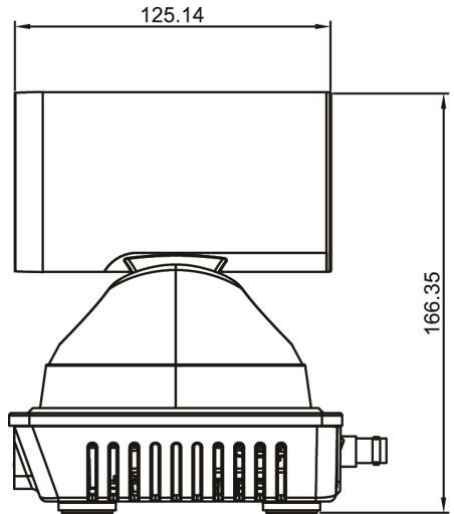

4.4 Dimension

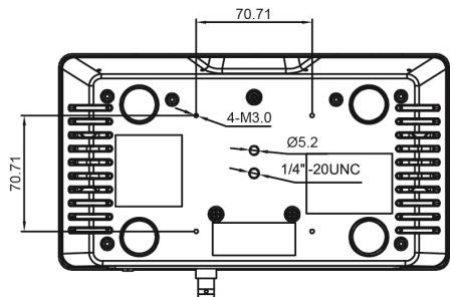
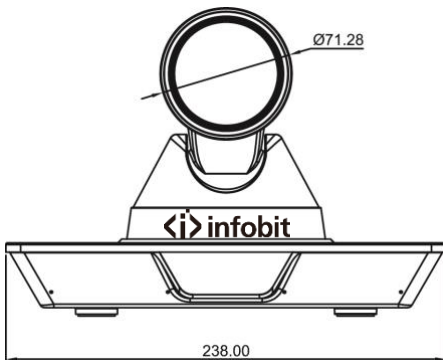

4.5 Remote Control

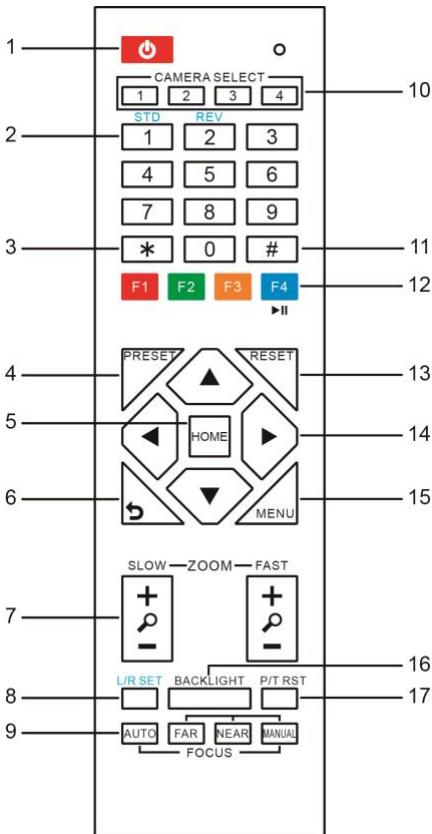

Key Description

1. Standby Key

Press this button to enter standby mode. Press it again to enter normal mode.

Note: Power consumption in standby mode is approximately half of the normal mode

2. Number Key

To set preset or call preset.

3. *Key

Used with other buttons.

4. Preset Key

Set preset: Store a preset position.

[SET PRESET] + Numeric button (0-9): Setting a corresponding numeric key preset position.

5. HOME Key

Confirm menu, enter the submenu or the PTZ will back to the middle position after pressed it

6. Return Key

Return back the last level menu

7. Zoom Key

Slow Zoom: Zoom In [+] or Zoom Out [-] slowly
Fast Zoom: Zoom In [+] or Zoom Out [-] fast

8. Left/Right Setting Key

Press with 1 button and 2 button setting the direction of the Pan-Tilt.

- Simultaneously press L/R Set +1[STD]: set the Pan-Tilt turn the same direction as the L/R Set.
- Simultaneously press L/R Set +2[REV]: set the Pan-Tilt turn the opposite direction as the L/R Set.

9. Focus Key

Used for focus adjustment.

Press [AUTO] adjust the focuses on the center of the object automatically.

Press [MANUAL] adjust the focus on the center of the object manual.

MANUAL button, and adjust it with [Far] (Focus on far object) and [NEAR] (Focus on near object).

10. Selection Key

Press the button corresponding to the camera you want to operate with the remote controller.

11. #Key

Used with other buttons.

12. IR Remote Control Key

[*]+[#]+[F1]: Address 1

[*]+[#]+[F2]: Address 2

[*]+[#]+[F3]: Address 3

[*]+[#]+[F4]: Address 4

13. Reset Key

Clear preset: Erase a preset position.

[CLEAR PRESET] + Numeric button (0-9)

Or: [*]+[#]+[CLEAR PRESET]: Erase all the preset individually.

14. PTZ Control Key

Press arrow buttons to perform panning and tilting. Press [HOME] button to face the camera back to front.

15. Menu Key

MENU: enter or exit OSD MENU.

16. Backlight Key

BLC ON/OFF: Press this button to enable the backlight compensation. Press it again to disable the backlight compensation.

NOTE:

- Effective only in auto exposure mode.
- If a light behind the subject, the subject will become dark. In this case, press the backlight ON/OFF button. To cancel this function, press backlight ON/OFF button.

17. PTZ Reset Key

Preset Pan/Tilt self-test.

18. Image Freezing Function

Manually freeze: Open the freezing function after press the remote control [F4], display "Freeze" on the left upper corner character, after five seconds display disappear automatically. If you want to cancel the freeze, press [F4] key and then can return to normal, display "Unfreeze" on the left upper corner, after five seconds display will disappear automatically.

Recalling the Preset image Freeze: By the OSD Menu "Image Freeze" to set recalling the preset image freeze function. After the function is opened, the screen will stay in before Recalling the Preset when Recalling the Preset, the screen can be switched to the preset position screen until the camera points to the preset position.

19. Shortcut Set

[*]+[#]+[1]: OSD menu default English
 [*]+[#]+[3]: OSD menu default Chinese
 [*]+[#]+[4]: Display current IP address
 [*]+[#]+[6]: Quickly recover the default
 [*]+[#]+[8]: View the camera version
 [*]+[#]+[9]: Quickly set up inversion
 [*]+[#]+[MANUAL]: Restore default IP address

4.6 RS232 Interface

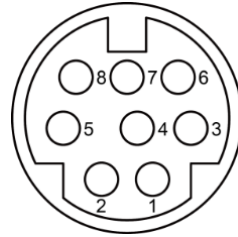

No.	Function
1	DTR
2	DSR
3	TXD
4	GND
5	RXD
6	GND
7	IR OUT
8	NC

The correspondence between the camera and Windows DB-9 pin:

Camera	Windows DB-9
1.DTR	1.CD
2.DSR	2.RXD
3.TXD	3.TXD
4.GND	4.DTR
5.RXD	5.GND
6.GND	6.DSR
7.IR OUT	7.RTS
8.NC	8.CTS
	9.RI

The correspondence between the camera and the Mini DIN pin:

Camera	Mini DIN
1.DTR	1.DTR
2.DSR	2.DSR
3.TXD	3.TXD
4.GND	4.GND
5.RXD	5.RXD
6.GND	6.GND
7.IR OUT	7.NC
8.NC	8.NC

4.7 Serial Communication Control

● RS232 Communication Control

The camera is controlled via RS232. The RS232 serial port parameters are as follows:

Baud rate: 2400/4800/9600/38400;

Starting position: 1 bit

Data bits: 8 bits

Stop bits: 1 bit

Parity: None

5 GUI Settings

5.1 MENU

Press [MENU] button to display the main menu on the normal screen, using arrow button to move the cursor to the item to be set. Press the [HOME] button to enter the corresponding sub-menu.

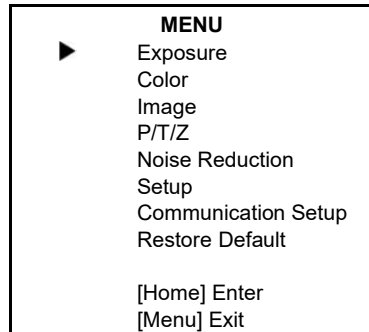

5.2 EXPOSURE

Move the main menu cursor to [EXPOSURE], and press [HOME] key enter the exposure page, as shown in the following figure.

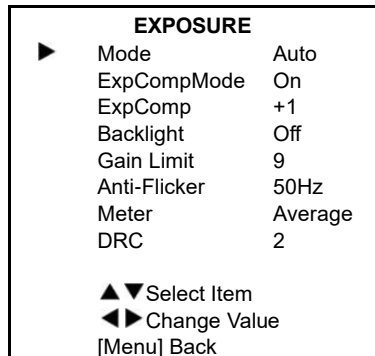

Mode: Exposure mode, optional items: Auto, Manual, SAE, AAE, Bright.

ExpCompMode: Exposure the compensation mode, optional items: On, Off (Effective only in Auto mode).

ExpComp: Exposure the compensation value, optional items: -7 ~ 7 (Effective only in ExpCompMode item to On).

Backlight: Set the backlight compensation, optional items: On, Off (Effective only in Auto mode).

Bright: Intensity control, optional items: 0 ~ 17 (Effective only in Bright mode).

Gain Limit: Maximum gain limit, optional items: 0 ~ 15 (Effective only in Auto, SAE, AAE, Bright mode).

Anti-Flicker: Anti-flicker, optional items: Off, 50Hz, 60Hz (Effective only in Auto, AAE, Bright mode).

Meter: Optional items: Average, Center, Smart, Top.

Iris: Aperture value, optional items: F1.8, F2.0, F2.4, F2.8, F3.4, F4.0, F4.8, F5.6, F6.8, F8.0, F9.6, F11.0, Close (Effective only in Manual, AAE mode).

Shutter: Optional items: 1/30, 1/60, 1/90, 1/100, 1/125, 1/180, 1/250, 1/350, 1/500, 1/725, 1/1000, 1/1500, 1/2000, 1/3000, 1/4000, 1/6000, 1/10000 (Effective only in Manual, SAE mode).

Gain: Optional items: 0 ~ 7 (Effective only in Manual mode).

DRC: DRC strength, optional items: 0 ~ 8.

5.3 COLOR

Move the main menu cursor to [COLOR], and press [HOME] key enter the color page, as shown in the following figure.

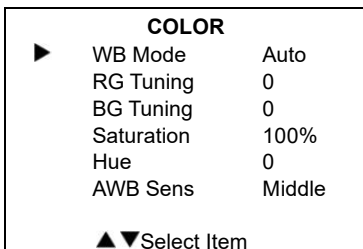
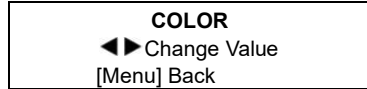

WB-Mode: White balance mode, optional items: Auto, Indoor, Outdoor, One Push, Manual, VAR.

RG Tuning: Red gain fine-tuning, optional items: -10 ~ +10 (Effective only in Auto, One Push, VAR mode).

BG Tuning: Blue gain fine-tuning, optional items: -10 ~ +10 (Effective only in Auto, One Push, VAR mode).

Saturation: Optional items: 60% ~ 200%.

Hue: Optional items: -10 ~ +10.

AWB Sens: The white balance sensitivity, optional items: Low, Middle, High.

RG: Red gain, optional items: 0 ~ 255 (Effective only in One Push, Manual, VAR mode).

BG: Blue gain, optional items: 0 ~ 255 (Effective only in One Push, Manual, VAR mode).

Color Temp: Optional items: 2500K ~ 8000K (Effective only in VAR mode).

5.4 IMAGE

Move the main menu cursor to [IMAGE], and press [HOME] key enter the image page, as shown in the following figure.

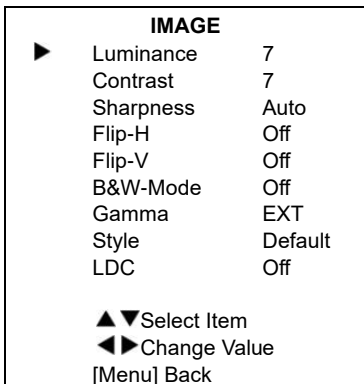

Luminance: Brightness adjustment, optional items: 0 ~ 14.

Contrast: Contrast adjustment, optional items:

0 ~ 14.

Sharpness: Sharpness adjustment, optional items: Auto, 0 ~ 15.

Flip-H: Image flipped horizontally, optional items: On, Off.

Flip-V: Image Flip Vertical, optional items: On, Off.

B&W-Mode: Optional items: On, Off.

Gamma: Optional items: EXT, PC, 0.48, 0.5, 0.56, 0.63.

Style: Optional items: Default, Norm, Bright, PC.

LDC: Optional items: Off, -10 ~ +10.

5.5 P/T/Z

Move the main menu cursor to [P/T/Z], and press [HOME] key enter the P/T/Z page, as shown in the following figure.

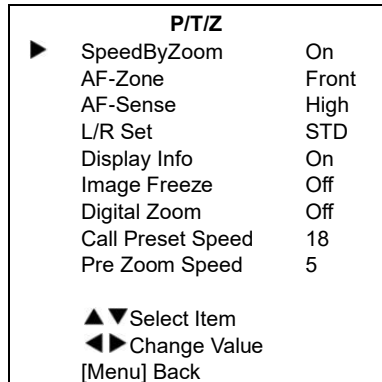

SpeedByZoom: The depth of field scale switch, optional items: On, Off.

AF-Zone: Interested in focusing area, optional items: Front, Top, Center, Bottom.

AF-Sense: Automatic focusing sensitivity options, optional items: Low, Normal, High.

L/R Set: Optional items: STD, REV.

Display Info: Optional items: On, Off.

Image Freeze: Optional items: On, Off.

Digital Zoom: Optional items: Off, 2x, 4x, 8x, 16x.

Call Preset Speed: Optional items: 1 ~ 24.

Pre Attr: Optional items: On, Off.

Pre Zoom Speed: Optional items: 0 ~ 7.

5.6 NOISE REDUCTION

Move the main menu cursor to [NOISE REDUCTION], and press [HOME] key enter the noise reduction page, as shown in the following figure.

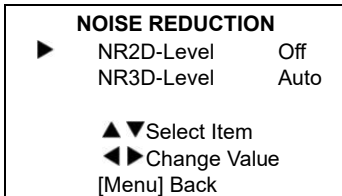

NR2D Level: 2D noise reduction, optional items: Off, Auto, 0 ~ 4.

NR3D Level: 3D noise reduction, optional items: Off, Auto, 0 ~ 7.

5.7 SETUP

Move the main menu cursor to [SETUP], and press [HOME] key enter the setup page, as shown in the following figure.

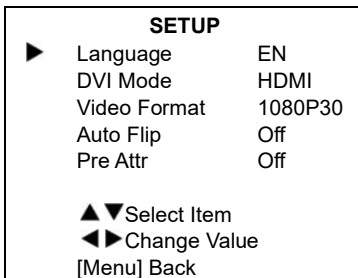

Language: Optional items: EN, Chinese, Russian.

DVI Mode: Optional items: DVI, HDMI.

Video Format: Optional items: 1080P60, 1080P50, 1080I60, 1080I50, 1080P30, 1080P25, 720P60, 1080P29.97, 1080I59.94, 1080P59.94, 720P59.94, 4KP29.97, 4KP59.94, 4KP25, 4KP30, 4KP50, 4KP60.

Auto Flip: Optional items: On, Off.

5.8 COMMUNICATION SETUP

optional items: Yes, No.

Move the main menu cursor to [COMMUNICATION SETUP], and press [HOME] key enter the communication setup page, as shown in the following figure.

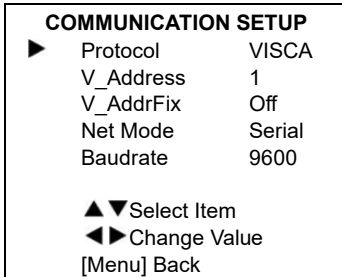

Protocol: Control protocol type, optional items: Auto, VISCA, PELCO-D, PELCO-P.

V_Address: Optional items: 1 ~ 7.

(Effective only in Auto, VISCA protocol).

V_AddrFix: Optional items: On, Off (When set to On, useless in 88 30 01 FF Command).

P_D_Address: Optional items: 0 ~ 254.

(Effective only in Auto, PELCO-D protocol).

P_P_Address: Optional items: 0 ~ 31.

(Effective only in Auto, PELCO-P protocol).

Net Mode: Set the serial port network control, optional items: Serial, Paral.

Baudrate: Serial port baud rate, optional items: 2400, 4800, 9600, 38400.

5.9 RESTORE DEFAULT

Move the main menu cursor to [RESTORE DEFAULT], and press [HOME] key enter the restore default page, as shown in the following figure.

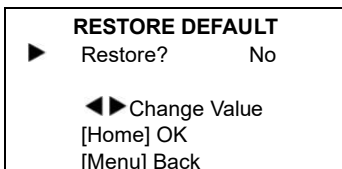

Restore: Confirm restore factory settings,

6 Network Function

6.1 Operating Environment

Operating System: Windows 7/8/10, Mac OS X, Linux, Android

Network Protocol: TCP/IP

Client PC: P4/128M RAM/40G HDD/ support scaled graphics card, support DirectX 8.0 or more advanced version.

6.2 Equipment Installation

- 1) Connect video conference camera to your internet or to your PC via network cable.
- 2) Turn on DC 12V power.
- 3) If the network connection is normal, the connection light (green) at the network interface will light up within 5 seconds, and the data indicator (orange) will flash, indicating that the physical connection of the camera has been completed.

6.3 Internet Connection

There are two main ways to connect video conference camera.



Connect by Network Cable

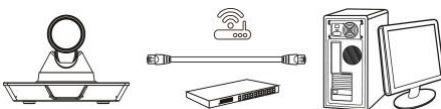

Connect by Switch/Router

6.4 Camera Controlled by LAN

6.4.1 Setup IP Address

If you don't know camera IP, view as below:

Method 1: Press * and # and 4 on remote controller one by one, the camera IP address will be shown on screen.

Method 2: Connect camera to PC with network cable, use "upgrade_En.exe" to search for IP address.



upgrade

Change IP address, two methods as below:

Method 1: Login the web page, select "Network > Lan Settings", change IP address, subnet mask and gateway. Click "Apply" and restart the camera.

Lan Settings

IP Configuration Type: Fixed IP Address

IP Address: 192.168.100.88

Subnet Mask: 255.255.255.0

Gateway: 192.168.100.1

DNS Address: 8.8.8.8

MAC Address: D4 : E0 : 8E : 97 : 9D : CF

Apply Cancel

Port Settings

HTTP Port number: 80 (80)

RTSP Port: 554 (554)

PTZ Port: 5678 (5678)

UDP Port: 1259 (1259)

Control Protocol Settings

Pelco-D Address: 0 (0-254)

Pelco-P Address: 0 (0-31)

RTMP(S) Settings

First stream: On Off Video Audio

MRL: rtmp://192.168.100.138/live/stream0

Second stream: On Off Video Audio

MRL: rtmp://192.168.100.138/live/stream1

RTSP Settings

RTSP Auth: On Off

ONVIF Settings

ONVIF: On Off

ONVIF Auth: On Off

Multicast Settings

Multicast: On Off

Address: 224.1.2.3

Port: 6688

SDK Settings

Active Connection: On Off

Address: 192.168.100.138

Port: 1234

NTP Settings

time zone: (GMT+08:00) Beijing, Chongqing, Hong Kong, Urumqi

NTP time sync: On Off

Server address: cn.ntp.org.cn

Time interval: 1440 minutes

Main time show: On Off

Position: X 0 Y 0 (0-100)

Sub time show: On Off

Position: X 0 Y 0 (0-100)

Change IP address:

- Step 1** Search the IP address of camera.
- Step 2** Select the camera IP of you want to change.
- Step 3** Select the config dialog of upgrade applets.
- Step 4** Change the IP address, netmask and gateway, then click "Set".
- Step 5** Finish.

6.4.2 Visit/Access Camera

Input http://192.168.100.88 to IE (better with IE web browser, others will cause little latency), a login window pop up, input username: admin, password: admin, shown as below:



Method 2: Open "upgrade_En.exe", change IP and click "Set". After modified, the video conference camera will be restart.

After login, shown as below:



If user first time use this camera by internet (only for new user), must install a player software (VLC). Please go to VLC website

<http://www.videolan.org/vlc/#download> and Install the 32-bit VLC (player software). After installation, login again, will show as above.

6.5 Camera Controlled by WAN

6.5.1 Setup IP Controlled by Dynamic DNS

Two dynamic DNS: DynDNS.org, 3322.org.

Router Port Mapping:

Take Tenda router for example, enter the Router Home Page (interface page), select “Advanced”- “Virtual Server”, add a new port number in “Ext Port”, add a new port number in “Int port”, put camera IP address to “Internal IP”, then select “Save”, shown as below:

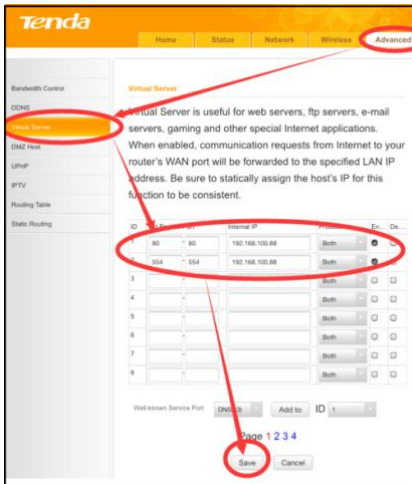

6.5.2 Dynamic DNS Visit Camera

Set domain name to camera, setup the parameter, then dynamic DNS can access camera. Access link: <http://hostname:portnumber>. For example, setup host computer name: youdomain.f3322.org, the camera port number is 89, the access link should be <http://youdomain.3322.org:89>.



If the camera port default is 80, then unnecessary to input port number, use host name can access camera directly.

6.5.3 VLC Stream Media Player Monitor

Visit VLC Media Server Procedure

Step 1 Open VLC media player.

Step 2 Click “Media > Open Network Stream”, or click “Ctrl + N”; as below:

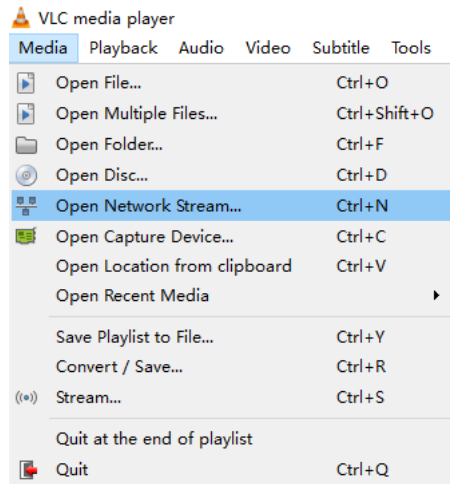

Step 3 Input URL address:

<rtsp://ip:portnumber/1> (First stream);

<rtsp://ip:portnumber/2> (Second stream).

Step 4 Click “Play”.



RTSP port number default 554. If the camera port default is 80, then unnecessary to input port number of URL address.

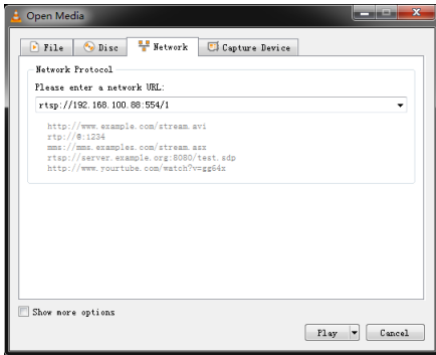

6.6 Camera Parameter Setup

6.6.1 Homepage Introduction

Menu

All pages include two menu bars:

Real time monitoring: displaying video image

Parameter setup: with function buttons.

A. Video Viewing Window

Video viewing window must be same as video resolution, the bigger the resolution is, the bigger the playing area is. Double click viewing window, will show full-screen, double click again, will return to initialized size.

Status bar in viewing window shown as below:



- 1) Video playback pause button: control real-time video pause, stop the last picture, click recoverable video again.
- 2) Audio control buttons: can adjust the volume or set silent mode.
- 3) Full screen switch button.

B. PTZ Setup

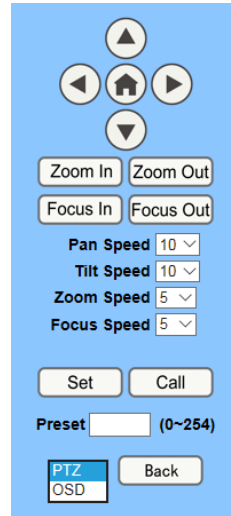

1) Pan and Tilt Control

Up, Down, Left and Right arrows and the home button allow you to manually drive the camera to the desired position.

2) Zoom

Zoom In and Zoom Out buttons allow for wide or narrow view of the space.

3) Focus

Focus In and Focus Out buttons allow for fine manual focus adjustment if the camera has any problems auto focusing on the difficult object.

4) PTZ Speeds

Pan speed can be set at any rate between 1 ~ 24, Tilt speed can be set at any rate between 1 ~ 20. Zoom and Focus speeds can be set at any rate between 0 ~ 7.

5) PTZ Presets

After manually setting up a shot that you would like to return to later, you can save presets for quick recall of these positions. Type a number

between 0 and 254 into the Preset box.

Click the "Set" button to save the current location with that preset number. Click the "Call" button to cause the camera to return to that position. This enables smooth, quick and convenient control without the need to manually drive the camera.

You can set up preset that user want as below.

Method 1: Type a number into the Preset box.

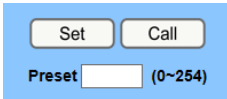

Preset: Optional items: 0 ~ 254.

Method 2: Type the name into the Presets Information.

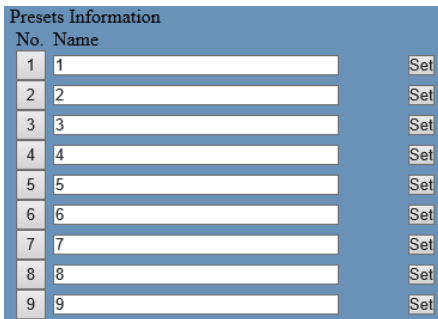

Click "Set" button, when PTZ turn to other position, click "Call" button or click "No." of the Presets Information, PTZ will turn back to preset position.

6) PTZ / OSD Dropdown

From the dropdown menu, clicking the OSD option will open the on-screen display menu of the camera giving you control from within the IP interface.

C. Language Selection

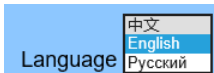

Click either "Chinese", "English" or "Russian"

to change the language of the webpage.

6.6.2 Video Settings

Video Settings

Video Format:

Encode Level:

First stream

Encode Protocol:

Resolution:

Bit Rate: (32~51200) kbps

Frame Rate: fps

I Key Frame Interval: (2~1200)

Bit Rate Control: CBR VBR

Fluctuate Level:

Slice Split Enable: On Off

Split Mode: Fixed blocks

Slice Size: blocks

Second stream

Encode Protocol:

Resolution:

Bit Rate: (32~20480) kbps

Frame Rate: fps

I Key Frame Interval: (2~1200)

Bit Rate Control: CBR VBR

Fluctuate Level:

Slice Split Enable: On Off

Split Mode: Fixed blocks

Slice Size: blocks

1) Video Format

Support 50Hz (PAL) and 60Hz (NTSC), and Dial Priority three formats.

2) Encode Level

Support baseline, mainprofile, highprofile and svc-t four levels.

3) Encode Protocol

Support H.264, H.265 and MJPEG three protocols.

4) Resolution

First stream support 3840x2160, 1920x1080, 1280x720, 1024x576, 960x540, 640x480, 640x360. Second stream support 1920x1080, 1280x720, 1024x576, 720x576 (50Hz support), 720x480 (60Hz support), 720x408, 640x360, 480x270, 320x240, 320x180; The bigger resolution is, the clearer the image will be, more network bandwidth will be taken.

5) Bit Rate

The user can specify the bit rate. Generally speaking, the larger of the bit rate, the clearer of the image. However, the configuration of the bit rate needs to be combined with the network bandwidth. When the network bandwidth is narrow and the bit rate is configured larger, the video stream cannot be transmitted normally, and the visual effect is worse.

6) Frame Rate

User can specify the size of the frame rate, generally, the frame rate greater, the image more smooth; Frame rate is smaller, the more sense of beating.

7) I Key Frame Interval

Set interval between 2 I frame, the bigger interval is the response will be lower from viewing window.

8) Bit Rate Control

Code stream control way:

Constant Bit Rate: Video coder will be coding according to preset speed.

Variable Bit Rate: Video coder will adjust the speed based on preset speed to gain the best image quality.

9) Fluctuate Level

Restrain the fluctuation magnitude of variable rate, grade 1 ~ 6.

10) Slice Split Enable

Enable or disable slice split function.

11) Split Mode

Select split mode, optional items: Fixed blocks, Fixed bytes.

12) Slice Size

Set the size of slice.

6.6.3 Image Settings



1) Brightness

Image bright 0 ~ 14, slider control, on the right shows the corresponding numerical. Default value is 7.

2) Saturation

Saturation 0 ~ 14, slider control, on the right shows the corresponding numerical. Default value is 4.

3) Contrast

Contrast 0 ~ 14, slider control, on the right shows the corresponding numerical. Default value is 7.

4) Sharpness

Sharpness 0 ~ 15, slider control, on the right shows the corresponding numerical. Default value is auto.

5) Hue

Hue 0 ~ 14, slider control, on the right shows the corresponding numerical. Default value is 7.

6) Flip & Mirror

Tick Flip to realize image upside down, tick mirror to realize image around the mirror. Default value is not tick.

6.6.4 Audio Settings

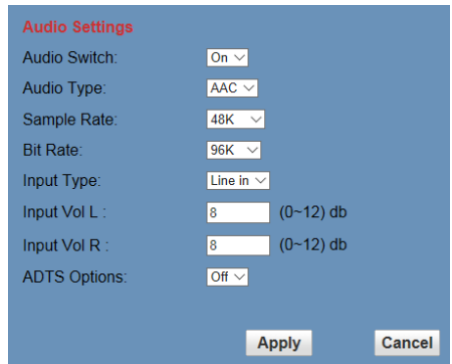

1) Audio Switch

Turn on or off audio switch.

2) Audio Type

Audio type AAC.

3) Sample Rate

Optional items: 44.1K, 48K.

4) Bit Rate

Optional items: 96K, 128K, 256K.

5) Input Type

Optional items: Line in, MIC.

6) Input Vol L

The volume of the left channel.

7) Input Vol R

The volume of the right channel.

8) ADTS Options

Optional items: On, Off.

6.6.5 System Settings

Initialize

Work Mode: ▼

Reboot:

User

UserName:

Password:

Guest:

Password:

1) Work Mode

The default work mode is RTSP.

Optional items: RTSP, SDK, Multicast.

2) Reboot

Click the “Reboot” button, system restart.

3) Username and password

The user can modify the password (letters and Numbers only).

6.6.6 Network Settings

Lan Settings

IP Configuration Type: Fixed IP Address ▼

IP Address:

Subnet Mask:

Gateway:

DNS Address:

MAC Address:

Port Settings

HTTP Port number: (80)

RTSP Port: (554)

PTZ Port: (5678)

UDP Port: (1259)

Control Protocol Settings

Peico-D Address: (0-254)

Peico-P Address: (0-31)

RTMP(S) Settings

First stream: On Off Video Audio

MRL:

Second stream: On Off Video Audio

MRL:

RTSP Settings

RTSP Auth: On Off

ONVIF Settings

ONVIF: On Off

ONVIF Auth: On Off

Multicast Settings

Multicast: On Off

Address:

Port:

SDK Settings

Active Connection: On Off

Address:

Port:

NTP Settings

time zone: (GMT+08:00) Beijing, Chongqing, Hong Kong, Urumqi ▼

NTP time sync: On Off

Server address:

Time interval: minutes

Main time show: On Off

Position: X Y (0-100)

Sub time show: On Off

Position: X Y (0-100)

1) Lan Settings

Default the IP address is 192.168.100.88, the MAC address cannot be modified.

2) Port Settings

A. HTTP Port

IP address identifies the network device, the device can run multiple web applications, each network program using network port to transmit data, so data transmission to be carried out between the port and port. Port setting is to set up web server program using which port to transmit. When port mapping, need to be consistent with the port number (default port: 80).

B. RTSP Port

The video conference camera support RTSP

protocol, use the VLC tools broadcast, default port: 554.

C. PTZ Port

Support TCP connection then control camera, default port: 5678.

D. UDP Port

Support UDP protocol, default port: 1259.

3) Control Protocol Settings

Setting the camera control communication protocol, include Visca address, Pelco-D address and Pelco-P address.

4) RTMP(S) Settings

Setting the MRL of RTMP, select enable or disable video and audio. You can select control code stream of "On", "Off", "Video", "Audio" between in the two streams.

5) RTSP Settings

Turn On/Off RTSP auth.

6) ONVIF Settings

Turn On/Off ONVIF and ONVIF auth.

7) Multicast Settings

Turn On/Off multicast. Setting the multicast address (default value is 224.1.2.3) and port (default value is 6688, then 6688 is the multicast port of the first stream; 6690 is the multicast port of the second stream).

8) SDK Settings

Turn On/Off active connection. Setting SDK address (default value is 192.168.100.138) and port (default value is 1234).

9) NTP Settings

Turn On/Off NTP time sync, main time show and sub time show. Setting NTP server address, time interval, main stream position and sub stream position.

6.6.7 Device Information

Display the current device information, as shown below.

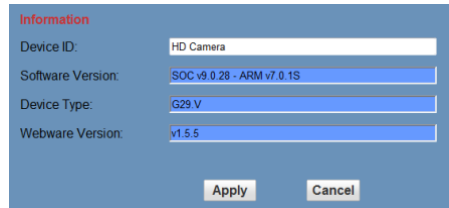

Information	
Device ID:	HD Camera
Software Version:	SOC v3.0.28 - ARM v7.0.13
Device Type:	G29 V
Webware Version:	v1.5.5

6.7 Download the Upgrade Program

If you need the camera upgrade program, please contact the manufacturer.

7 Maintenance and Troubleshooting

Camera Maintains

- If camera will not be used for a long time, please turn off the power switch, disconnect AC power cord of AC adaptor to the outlet.
- Please use soft cloth or tissue to clean the camera cover.
- Please use the soft dry cloth to clean the lens. If the camera is very dirty, clean it with diluted neuter detergent. Do not use any type of solvents, which may damage the surface.

Unqualified Application

- No shooting extreme bright object for a long period of time, such as sunlight, light sources, etc.
- No operating in unstable lighting conditions, otherwise image will be flickering.
- No operating close to powerful electromagnetic radiation, such as TV or radio transmitters, etc.

Troubleshooting

Image

- The monitor shows no image
 - 1) Check that the camera power supply is connected, the voltage is normal, and the power indicator light is always on.
 - 2) Turn off the power switch to check whether the camera is self-testing.
 - 3) Check the cable of video platform and TV whether correct connection.
- Sometimes without the image

Check the cable of video platform and TV whether correct connection.

- Image have jitter when the camera lens at max multiple
 - 1) Check whether the camera installed position be stabled.
 - 2) Check whether have vibrating machinery or object near the camera.
- There is no video image in IE Browser

Please visit VLC website

(<http://www.videolan.org/vlc>) download and install the 32-bit VLC media player, after it installed, visit video conference camera will have normal image display.

- Unable to access video conference camera through IE Browser
 - 1) Using PC to access the network to test whether the network access can work properly, first of all, the network fault caused by the PC virus can be eliminated, until the PC and video conference camera can communicate with each other Ping.
 - 2) Disconnect the network, connect video conference camera and PC separately, and reset the IP address of PC.
 - 3) Check IP address, subnet mask, and gateway settings for video conference camera.
 - 4) Check whether the MAC address is conflicts.
 - 5) Check whether the web port is modified. The default is 80.

- Forget the IP address or login password

Please remember (The default IP address: 192.168.100.88; default user name: admin; default password: admin).

Control

- Remote control cannot control
 - 1) Check and replace the new battery for the remote controller.
 - 2) Check whether the camera working mode is correct.
 - 3) Check whether the address of remote control can match the camera.
- Serial port cannot control
 - 1) Check whether the camera protocol, address and baud rate such is the same.
 - 2) Check whether the control line is connected well.