

**i**CON







**DT-5A air**  
**DT-6A air**  
**DT-8A air**

Definitor air Series 5.25"/6.5"/8.0"  
Active Studio Monitor System  
with "AirCon" wireless control module

Owner's Manual



EN1630

	<p><b>CAUTION</b></p> <p>RISK OF ELECTRIC SHOCK DO NOT OPEN RISQUE DE CHOC ELECTRIQUE NE PAS OUVRI</p>			<p>The lightning flash with arrowhead symbol within an equilateral triangle is intended to alert the user to the presence of uninsulated dangerous voltage within the product's enclosure, that may be of sufficient magnitude to electric shock to persons. Le symbol clair avec point de flèche à l'intérieur d'un triangle équilatéral est utilisé pour alerter l'utilisateur de la présence d'intérieur du coffret de voltage dangereux non isolé d'ampleur suffisante.</p> <p>The exclamation point within an equilateral triangle is intended to alert the user of the presence of important operating and maintenance (servicing) instructions in the literature accompanying the appliance. Le point d'exclamation à l'intérieur d'un triangle équilatéral est employé pour alerter les utilisateurs de la présence d'instructions importantes pour le fonctionnement et l'entretien (service) dans le livret d'instruction accompagnant l'appareil.</p>
	<p>CAUTION: TO REDUCE THE RISK OF ELECTRIC SHOCK DO NOT REMOVE COVER (OR BACK) NO USER-SERVICEABLE PARTS INSIDE REFER SERVICING TO QUALIFIED PERSONNEL</p> <p>ATTENTION: POUR EVITER LES RISQUES DE CHOC ELECTRIQUE: NE PAS ENLEVER LE COUVERCLE. AUCUN ENTRETIEN DE PIECES INTERIEURES PAR L'USAGER CONFIER L'ENTRETIEN AU PERSONNEL QUALIFIE</p> <p>AVIS: POUR EVITER LES RISQUES D'INCENDIE OU D'ELECTROCUTION, N'EXPOSEZ PAS CET ARTICLE A LA PLUIE OU A L'HUMIDITE</p>			



## Important Safety Instructions

1. Read this manual thoroughly before using this unit.
2. Keep this manual for future reference.
3. Take notice of and comply with all warnings included in the user's manual or indicated on the appliance.
4. Follow all instructions included in this manual.
5. Do not expose this unit to rain or moisture. Avoid having water or other liquids spilled on this unit.
6. When cleaning the cabinet or other parts of this appliance, use only a dry or slightly damp soft cloth.
7. Do not block any ventilation openings or interfere with the proper ventilation of this unit. Install in accordance with the manufacturer's instructions.
8. Do not use or store near any heat sources such as radiators, heat registers, stoves, or other heat-producing appliances.
9. Do not interfere with the safety purpose of the polarized or grounding-type plug. A polarized plug has two blades with one wider than the other. A grounding-type plug has two blades and a third grounding prong. These are designated for your safety. If the provided plug does not fit into your outlet, consult an electrician.
10. Protect the power cord from being walked on or otherwise damaged by items placed on or against them. Particular attention should be given to the plugs, receptacles, and the point where the cord exits the appliance.
11. To avoid the risk of electrical shock, do not touch any exposed wiring while the unit is in operation.
12. Only use attachments/accessories specified by the manufacturer.
13. Unplug this unit and all connected electrical equipment during lightning storms or when left unused a long period of time.
14. Refer all servicing to qualified service personnel. Servicing is required when the appliance has been damaged in any way or fails to operate normally.

**WARNING: To reduce the risk of fire or electric shock, do not expose this unit to rain or moisture**

# Contents



<b>Introduction</b> .....	<b>1</b>
<b>What's in the package</b> .....	<b>1</b>
<b>Register your ICON ProAudio product to your personal account</b> .....	<b>2</b>
<b>Features</b> .....	<b>3-4</b>
<b>Front Panel Layout</b> .....	<b>4</b>
<b>Rear Panel Layout</b> .....	<b>5</b>
<b>LCD Display Layout</b> .....	<b>6</b>
<b>Setting Up your DT-air Active Studio Monitor System</b> .....	<b>7-8</b>
<b>Background on the DT-air Active Studio Monitor System</b> .....	<b>7</b>
<b>Positioning the DT-air</b> .....	<b>7</b>
<b>Speaker Orientation</b> .....	<b>8</b>
<b>Reflection</b> .....	<b>8</b>
<b>Connecting your DT-air Active Studio Monitor System</b> .....	<b>9-10</b>
<b>DT-air Quick Connections</b> .....	<b>9</b>
<b>Cabling</b> .....	<b>10</b>
<b>Operating your DT-air Active Studio Monitor System</b> .....	<b>11-12</b>
<b>DT-air Control and Connectors Panels</b> .....	<b>11</b>
<b>Powering the DT-air</b> .....	<b>11</b>
<b>Things that go hum!</b> .....	<b>11</b>
<b>Front Panel Controls</b> .....	<b>11</b>
<b>The Rear Panel: The Ins and the Outs</b> .....	<b>12</b>
<b>Specifications</b> .....	<b>13</b>
<b>Services</b> .....	<b>14</b>

# ***Introduction***

Thank you for purchasing the ICON DT-air series active studio monitor system. We sincerely trust this product will provide years of satisfactory service, but if anything is not to your complete satisfaction, we will endeavor to make things right.

In these pages, you'll find a detailed description of the features of the DT-air, step-by-step instructions for its setup and use, and full specifications.



Please register the product on our website at the below link [www.iconproaudio.com/registration](http://www.iconproaudio.com/registration):

You'll also find a warranty card enclosed---please don't forget to fill it out and mail it so that you can receive online technical support at: [www.iconproaudio.com](http://www.iconproaudio.com). And so we can send you updated information about these and other ICON products in the future. As with most electronic devices, we strongly recommend you retain the original packaging. In the unlikely event the product must be returned for servicing, the original packaging (or reasonable equivalent) is required.

With proper care , your DT-air will operate without any trouble for many years. We recommend that you record your serial number in the space provided below for future reference.

## ***What's in the package?***

- DT-5 air / DT-6 air or DT-8 air Active Studio Monitor System
- This users' Manual
- Power Cable
- "Vasorb<sup>TM</sup>" monitor rubber feet x 4pcs.

## ***Register your ICON ProAudio product to your personal account***

### **1. Check serial number of your device**

Please go to [http:// iconproaudio.com/registration](http://iconproaudio.com/registration) or scan the QR code below.



Input your device's serial number and the other information on the screen. Click "Submit".

A message will pop up showing your device information such as model name and its serial number - Click "Register this device to my account" or if you see any other message, please contact our after-sales service team

### **2. Log in to your personal account page for existing user or sign up for new user**

Existing user: Please log into your personal user page by inputting your user name and password.

New user: Please click "Sign Up" and fill in all the information.

### **3. Download all useful materials**

All your registered devices under your account will show on the page. Each product will be listed along with all its available files such as drivers, firmware, user manual in different languages and bundled software etc. for download.

Please make sure you have download the necessary files such as driver before you begin device installation.

# Features

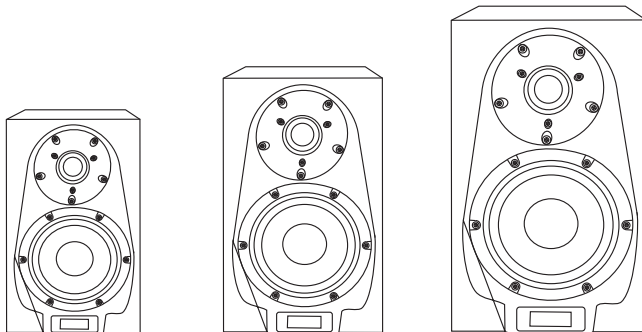

The ICON DT-air Active Studio Monitor System provides a smooth and accurate response which makes the system pleasant to listen to. It is equipped with ICON's innovative "AirCon" wireless control module which enables you to have ultimate wireless control on your studio settings. Here are some of its main features:

- Compact high performance active studio monitor
- R-Type transformer for super clean output
- Active 2-Way monitor system with professional crossover design
- The ideal solution for near-field monitoring in any recording or broadcasting facility
- Designed for use in stereo as well as multichannel setups
- Tuned by top acoustic engineers to fulfill any requirements in real recording studio environments
- ICON's "Vasorb™" monitor rubber feet are included
- Build-in Bi-Amp power module for low and high frequency drivers
  - DT-5A air : 80-watts on LF and 40-watts on HF
  - DT-6A air : 120-watts on LF and 60-watts on HF
  - DT-8A air : 150-watts on LF and 80-watts on HF

## Mid/Woofers

- ICON Custom designed 5.25" / 6.5" / 8.0" woofer
- Nomex® reinforced paper cone for crisp, clean and very open reproduction
- Low loss SBR surround with low creep and long time reliability
- Progressive spider to achieve soft clipping and low distortion even under extreme load
- Heavy dual magnet ferrite magnet system with extended height for superb bass reproduction
- Aluminum short circuiting ring and copper cap in magnet system that practically eliminates motor distortion
- Very rigid die-cast aluminum chassis with very open geometry for optimized air-flow to eliminate compression

## Tweeter

- High-end 1" dome tweeter
- Soft fabric dome and surround with wide-dispersion optimized geometry
- Big surround to reduce distortion
- Low loss ferrofluid-free magnet system for open and detailed sound
- Heavy ferrite under-hung dual magnet system for high sensitivity and low distortion
- Extended and air-flow optimized back cavity to ensure low compression and low resonance frequency
- Rugged die-cast aluminum faceplate with wide-dispersion optimized geometry

# Features

## Cabinet

- Robust and very rigid design
- Diffraction optimized smooth front baffle design
- Extended front baffle dimensions to eliminate any vibration or sound radiation from the enclosure
- Premium absorbing material for long-life high-performance bass reproduction



## AirCon™ Wireless Controller Module fully integrated

- Remote controlled volume and mute
- High, Mid and Low range contour control
- High-Pass Filter - Flat, 60Hz & 80Hz selectable
- LCD Display

## Front Panel Layout

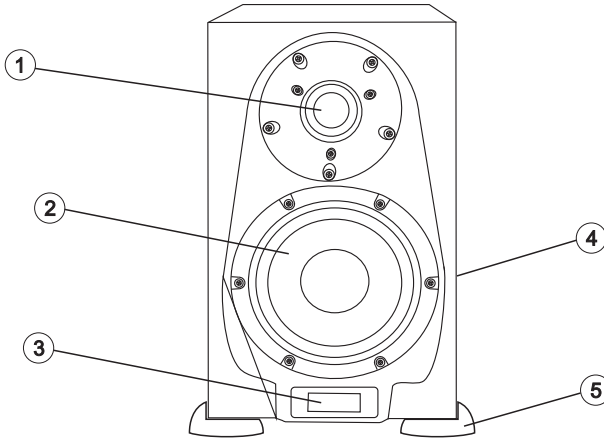

① **1" Soft fabric dome tweeter**

Smooth high frequency response produced from soft fabric dome, low-loss ferrofluid-free magnet system for open and detailed sound

② **Low frequency driver - woofer**

Custom designed 5.25"/ 6.5"/8.0" Nomex® reinforced paper cone woofer for crisp, clean and very open reproduction

③ **LCD**

"Communication Central" showing all the settings such as Hi, Mid, Low, HP filter, volume and LF clipping etc. of your DT-air monitor system.

④ **Cabinet and Finish**

18mm MPF for DT-5A air, 22mm MPF for DT-6A air and 25mm MPF for DT-8A air with rigid construction. Durable spray finish for the front panel and wood texture coating on body

⑤ **"Vasorb™" monitor rubber feet**

ICON large rubber feet keep enclosure in place even at high sound pressure levels.

# Rear Panel Layout

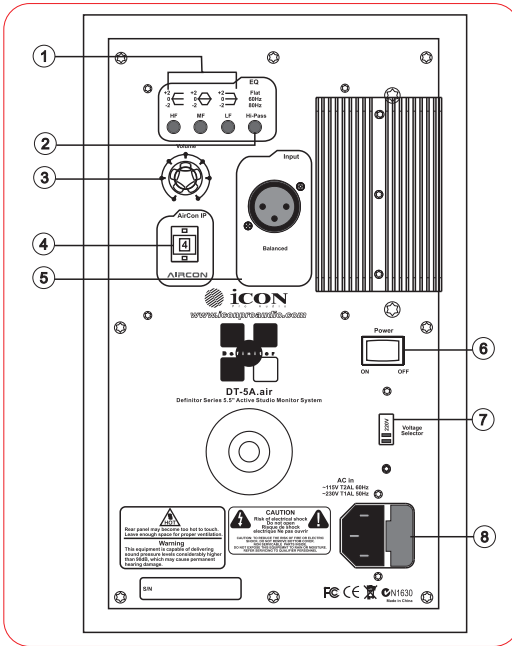

- ① **Hi, Mid and Low range contour control**  
Adjusts the 3-settings (-2dB, 0dB, +2dB) of Hi, Midrange and Low response providing customized adjustment for different acoustic environment.
- ② **Hi-Pass filter control**  
Adjusts the Hi-Pass filter from Flat, 60Hz & 80Hz
- ③ **Volume control**  
Controls the output level
- ④ **"AirCon™" IP setting**  
Sets the unique IP address of your DT-air monitor system for the AirCon wireless controller (You do not need to adjust this setting unless you have purchased the ICON "AirCon" wireless controller and are creating wireless control for your studio monitor system. Please refer to the AirCon manual for instructions on the setting)
- ⑤ **XLR balanced input**  
Connects balanced, line level input via standard XLR cable.  
(Please refer to P.8 for cabling)
- ⑥ **Power Switch**  
Turns the unit on/off.
- ⑦ **Voltage Selector**  
110V / 220V input voltage selector
- ⑧ **AC inlet**  
Connects the supplied IEC power cable.



# LCD Display Layout

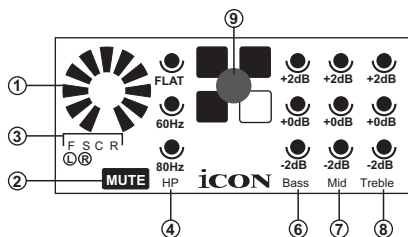

For all Monitor system

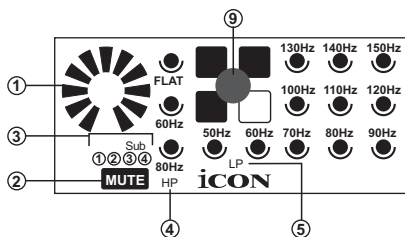

For Subwoofer system



- ① **Volume**  
Showing the output level of the DT-air active monitor system
- ② **Mute**  
Shown when the monitor system has been muted.  
*Note: You must have the "AirCon™" wireless controller to activate the mute function.*
- ③ **Position Identification**  
Showing the particular monitor's position as followings:  

FⓁ - Front Left Monitor	FⓇ - Front Right Monitor
SⓁ - Side Left Monitor	SⓇ - Side Right Monitor
C - Centre Monitor	
RⓁ - Rear Left Monitor	RⓇ - Rear Right Monitor
Sub① - Subwoofer 1	Sub② - Subwoofer 2
Sub③ - Subwoofer 3	Sub④ - Subwoofer 4

  
*Note: You may ignore the position identification showing on the LCD of your studio monitor if you are not using "AirCon™" wireless controller. The position identification of each monitor system is assigned by the "AirCon™" IP switch located on the back of the monitor system. You do not need to do the settings unless you are using "AirCon™" wireless controller and are creating wireless control for your studio monitor system.*
- ④ **HP ( For all monitors system including subwoofer )**  
Showing the High-pass filter setting of the monitor system/subwoofer: Flat, 60Hz and 80Hz
- ⑤ **LP ( For Subwoofer only )**  
Showing the Low-Pass filter setting of the subwoofer system: From 50Hz to 150Hz at 10Hz interval.
- ⑥ **Bass ( For all monitors system except subwoofer )**  
Showing the bass setting of the monitor system: +2dB / 0dB / -2dB
- ⑦ **Mid ( For all monitors system except subwoofer )**  
Showing the mid-range setting of the monitor system: +2dB / 0dB / -2dB
- ⑧ **Treble ( For all monitors system except subwoofer )**  
Showing the treble setting of the monitor system: +2dB / 0dB / -2dB
- ⑨ **Definitor logo ( For all monitor system including subwoofer )**  
The "Definitor" logo will flash when the bass signal is clipping. This is very useful as usually the bass signal clipping is not easy to be noticed by ear.

# Setting up your DT-air Active Studio Monitor System

## Background on the DT-air Active Studio Monitor system

The DT-air is a near field studio monitor featuring a custom design with 5.25", 6.5" or 8.0" Nomex® reinforced paper cone woofer and a 1" soft fabric dome tweeter with a low-loss ferrofluid-free magnet system. The monitor's crossover has been carefully designed by professional engineers with high quality components, ensuring a linear frequency and phase response. The DT-air enclosure is constructed from MDF. It is designed with a tuned vent port that provides extended low-end response, and with a low turbulence design. The low-frequency driver can move freely with minimal effect on the overall impedance. On the rear of the enclosure there is a XLR input connector. This is connected to the DT-air internal Bi-Amp power module and provides power to the woofer and tweeter. You will also find the pre-amp controls, including volume, used to adjust the overall level of the internal power amplifier, as well as the innovative Hi, Mid-range and Low presence control. These controls allow the mix engineer to contour the Hi, Mid-range and Low response of the monitor from traditional hi-fi sound to flat sound and then through two levels of aggressive Hi, Mid-range and Low response. The DT-air has been designed to provide flat, accurate monitoring, and at the same time, to provide an adjustable response curve so that the sound of other popular near field monitors can be easily emulated.



## Positioning the DT-air monitor

Near field monitoring has become the choice of many engineers in large and small studios because it minimizes the effect of room acoustics. By positioning the reference monitors in the near field (close to the listener), you can greatly reduce the effects of room acoustics.

The most important considerations when evaluating the effects of room acoustics are the reflective surfaces around the monitoring area. These can include flat tabletops, glass mirrors, framed pictures, large open walls and even the surface of your mixing console. All reflecting sound will eventually reach the listening position, but since it is slightly delayed from the direct source, the result is random cancellation of some frequencies, or comb filtering. If possible, remove any and all reflective surfaces. You may also want to attach some acoustic foam to walls that are close to the monitors.

When positioning the monitors, you will want to set up what is commonly referred to as the "mixing triangle". In this ideal configuration, the space between the left and right monitor is equal to the distance from the listener to each monitor, forming an equilateral triangle (as shown in Figure 1).

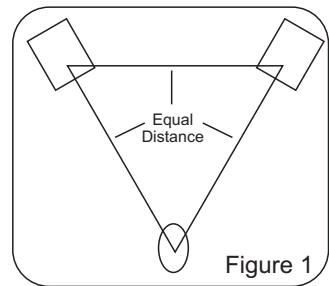

# Setting up your DT-air Active Studio Monitor System

## Speaker Orientation

The DT-air Active Studio Monitor system can be used in either the vertical or horizontal position. When using the monitors in the horizontal position, be certain to place the left and right side tweeters on the outermost sides. (As shown in Figure 2). This will improve the stereo imaging and bass response by increasing the coupling of the low-end drivers.

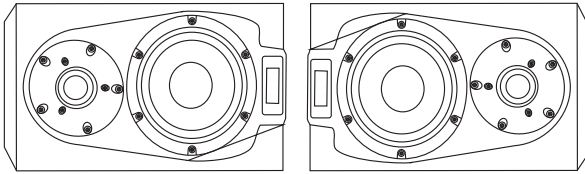
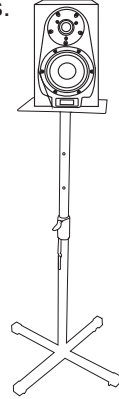

Figure 2



SB100X  
ICON Studio Monitor Stand(optional)

## Reflection

When choosing the height of your monitor system, be careful to avoid reflections off the surface of the mixing console (As shown in Figure 3). These reflections arrive at the listening position with a slight delay from the original sound, resulting in strange cancellations and an overall unpredictable response. Visualize straight lines representing the beams of sound radiating from the monitors and choose a height that reduces the occurrence of reflections that will end up in the prime listening spot (As shown in Figure 4). In most cases, the ideal position is slightly behind and above the mixing console's meter bridge.

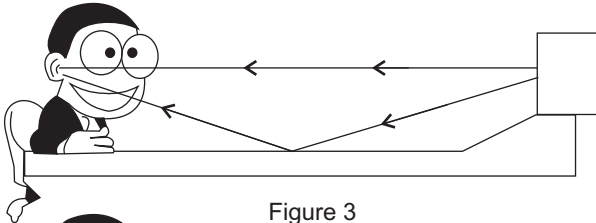

Figure 3

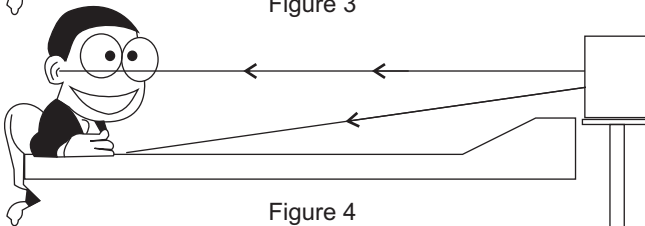

Figure 4

# Connecting your DT-air Active Studio Monitor System

## DT-air Quick Connections

Note: Before plugging in and turning on, remember the "last on, first off" rule of power amplifiers (and powered monitors). When powering up your system, be sure that all the wires are connected, turn your mixer and any other outboard gears on, and then finally turn on your DT-air monitor. When powering down, turn your DT-air monitor system off first and then your mixer and outboard gears.

The DT-air monitor system connection can be made via the balanced input at the rear panel. You can use XLR balanced +4dBu level signals input.

Follow the simple steps and diagram below for a quick connection using a standard recording console's control room outputs (such as ICON's imix).

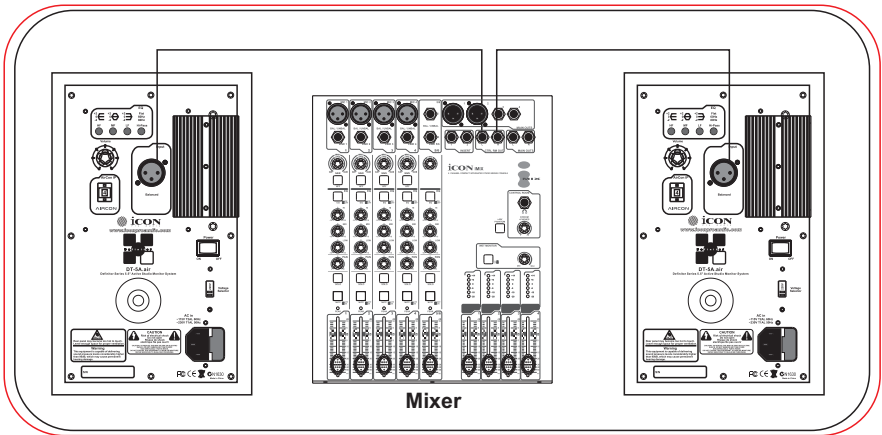

- Lower your mixer's master outputs as far down as possible.
- Connect the mixer's left Control Room output to the left-side DT-air's balanced input and the mixer's right Control Room output to the right-side DT-air's balanced input.
- Set the DT-air's input volume control to the 2 o'clock position. (The volume setting is displayed on the LCD on the front panel)
- Run an audio signal (such as some music from a CD) through your mixer and raise the Control Room level to a comfortable listening level.

# Connecting your DT-air Active Studio Monitor System

## Cabling



### Unbalanced 1/4" connector

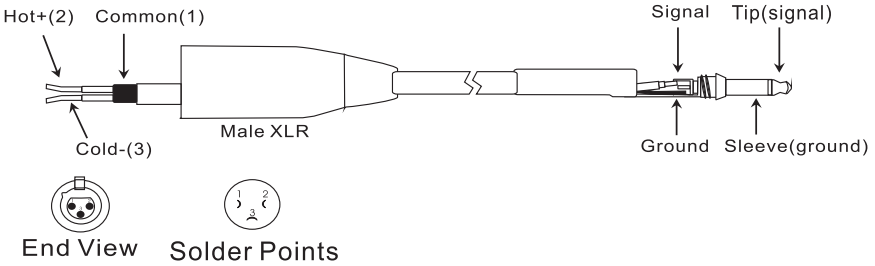

### Balanced TRS1/4" connector

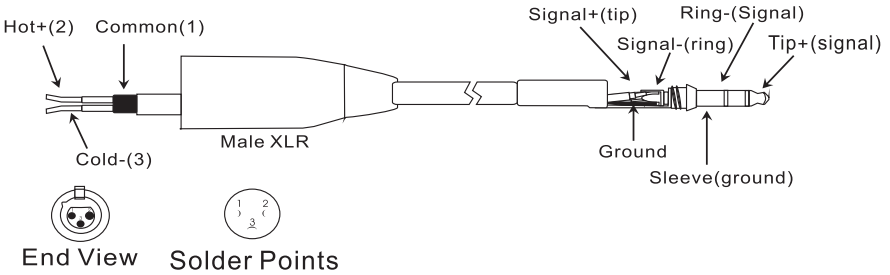

### Balanced TRS1/4" connector

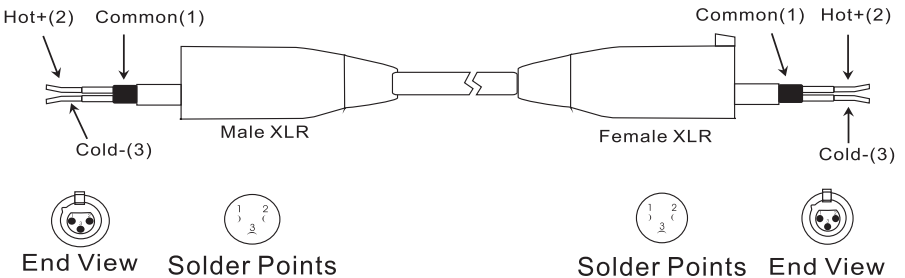

# Operating your DT-air Active Studio Monitor System

## DT-air Control & Connector Panels

The DT-air's rear panel is where you will make your connections for both AC power and audio signal. The rear panel also contains the controls to make adjustments to the overall volume and frequency response curve. The following section details the rear panel controls and connections.

**Tips: You may control your DT-air monitor system (up to 7.3 setting) with our innovative "Aircon™" wireless controller. For details, please contact our dealers or visit [www.iconproaudio.com](http://www.iconproaudio.com).**

## Powering the DT-air Active Studio Monitor System

Connect the unit to an AC power supply since the DT-air is an active studio monitor with an on-board power amplifier. Make sure that the main power switch is set to the off position and connect the supplied IEC power cable to the AC inlet.

## Things that go Hum!

When running power cables, be careful not to run the AC power cords or AC extension cords in parallel to your input cable. This will help reduce any AC hum that can be picked up. If you have to cross them then do so at a 90 degree angle for the least amount of induced hum. Using the DT-air's balanced input connector will greatly protect against the induced hum thanks to the common mode rejection (the induced hum is phase cancelled) provided by the balanced input circuit.

- ① **Power switch**  
Turns the unit on/off.
- ② **AC inlet**  
Connect the supplied IEC power cable here.
- ③ **Hi-Pass Filter control**  
Adjusts the Hi-Pass filter from Flat, 60Hz and 80Hz. (The Hi-Pass setting is display on the LCD on the front panel)
- ④ **LF, MF & HF controls**  
The DT-air's rear panel provides three important controls for adjusting the overall sound of the monitor's bass, midrange and treble. Adjust these controls to your preferred setting. If you take your monitors to other studios you may find these controls extremely useful in adjusting the sound for the new room.

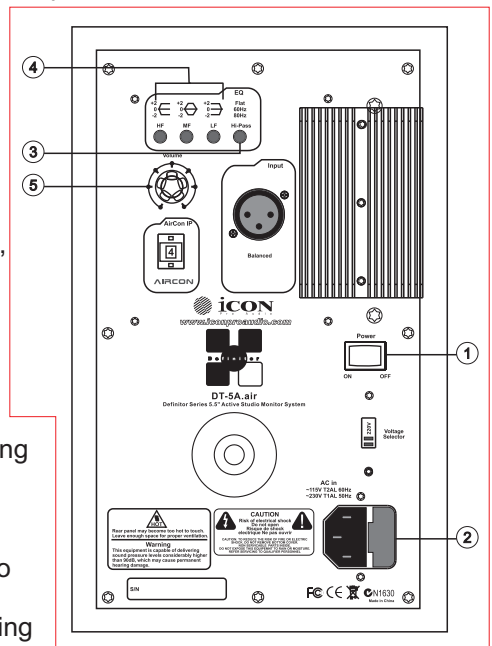

# Operating your DT-air Active Studio Monitor System



## 5 Volume control

The volume control is used to adjust the overall output level of the DT-air monitor system. When operating the unit for the first time, start with the volume control turned right down. Slowly raise the volume control to reach a comfortable listening level.

## The Rear Panel: The Ins and the Outs

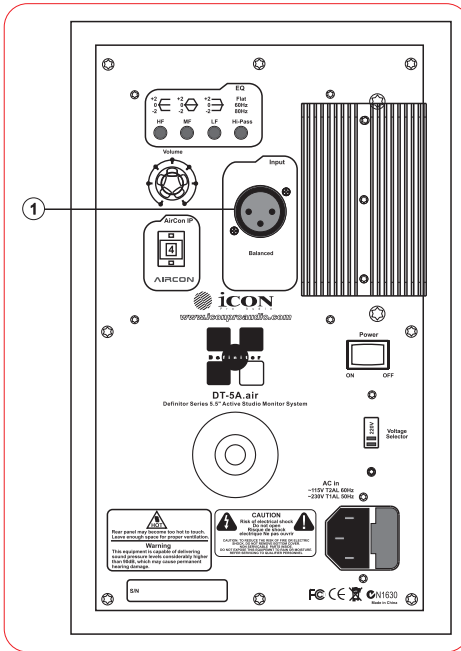

The DT-air is equipped with a balanced input connector providing connection to a variety of audio devices like recording consoles, hard disk recorders, CD players and computer audio interfaces, to name just a few.

## 1 Balanced XLR Audio Input

The DT-air features a female XLR connector that will accept a balanced or unbalanced +4dBm line level signal. If you are using a mixer that has balanced output on the XLR connector, you can make the connection via standard XLR cable. (For an unbalanced signal, please refer to P.8 "cabling" for instructions regarding for the cabling for an unbalanced connection )



## Specifications

	DT-5A air	DT-6A air	DT-8A air
System	Two-way active nearfield monitor	Two-way active nearfield monitor	Two-way active nearfield monitor
Frequency Response (+/-3dB)	45 Hz - 25 kHz	40 Hz - 25 kHz	35 Hz - 25 kHz
Max SPL 12 m, pair in listening room (IEC Short Term)	113 dB peak	116 dB peak	120 dB peak
Bass Principle	Bass reflex	Bass reflex	Bass reflex
Tuning Frequency	50 Hz	45 Hz	40 Hz
Tweeter	1" wide dispersion soft dome	1" wide dispersion soft dome	1" wide dispersion soft dome
Woofer	5.25" Nomex paper cone	6.5" Nomex paper cone	8" Nomex paper cone
Magnetically shielded/compensated	Shielded and Compensated	Shielded and Compensated	Shielded and Compensated
Cross over frequency	2.8 kHz	2.5 kHz	2.2 kHz
Cross over slope	24 dB/oct (LP and HP)	24 dB/oct (LP and HP)	24 dB/oct (LP and HP)
Input level for 100 dB SPL @ 500-2000 Hz avg @ 1 m	0 dBu RMS @ 0 dB level setting	0 dBu RMS @ 0 dB level setting	0 dBu RMS @ 0 dB level setting
Input connector	Balanced XLR	Balanced XLR	Balanced XLR
User settings (on the rear panel)			
Power	2 pos switch (On/Off)	2 pos switch (On/Off)	2 pos switch (On/Off)
Input sensitivity	20 pos encoder (0 dB to mute)	21 pos encoder (0 dB to mute)	22 pos encoder (0 dB to mute)
High Pass Control (remote controlled)	3 pos switch (Flat / 60 Hz / 80 Hz)	3 pos switch (Flat / 60 Hz / 80 Hz)	3 pos switch (Flat / 60 Hz / 80 Hz)
Bass control	3 pos switch (-2 dB / 0 dB / +2 dB)	3 pos switch (-2 dB / 0 dB / +2 dB)	3 pos switch (-2 dB / 0 dB / +2 dB)
Midrange control	3 pos switch (-2 dB / 0 dB / +2 dB)	3 pos switch (-2 dB / 0 dB / +2 dB)	3 pos switch (-2 dB / 0 dB / +2 dB)
Treble control	3 pos switch (-2 dB / 0 dB / +2 dB)	3 pos switch (-2 dB / 0 dB / +2 dB)	3 pos switch (-2 dB / 0 dB / +2 dB)
Power consumption	Idle: 15 W / Max: 120 W	Idle: 15 W / Max: 180 W	Idle: 15 W / Max: 230 W
Amplifier power	Tweeter: 40 W / Woofer: 80 W	Tweeter: 60 W / Woofer: 120 W	Tweeter: 80 W / Woofer: 150 W
Internal cabinet volume	8.5 liters	12.0 liters	14.5 liters
Weight	9.3 kg	12.0 kg	14.5 kg
Dimensions (WxHxD)	182 x 304 x 285 mm	208 x 334 x 322 mm	255 x 376 x 285 mm



## Services

### If your DT-air needs servicing, follow these instructions.

Check our online Help Center at <http://support.iconproaudio.com/hc/en-us>, for information, knowledge, and downloads such as:

1. FAQ
2. Download
3. Learn More
4. Forum

Very often you will find solutions on these pages. If you don't find a solution, create a support ticket at our online Help Center at the link below, and our technical support team will assist you as soon as we can.

Navigate to <http://support.iconproaudio.com/hc/en-us> and then sign in to submit a ticket.

As soon as you have submitted an inquiry ticket, our support team will assist you to resolve the problem with your ICON ProAudio device as soon as possible.

To send defective products for service:

1. Ensure the problem is not related to operation error or external system devices.
2. Keep this owner's manual. We don't need it to repair the unit.
3. Pack the unit in its original packaging including end card and box. This is very important. If you have lost the packaging, please make sure you have packed the unit properly. ICON is not responsible for any damage that occurs due to non-factory packing.
4. Ship to the ICON tech support center or the local return authorization. See our service centers and distributor service points at the link below:

If you are located in US

Send the product to:

North America

Mixware, LLC –U.S. Distributor

11070 Fleetwood Street –Unit F.

Sun Valley, CA 91352; USA

Tel.: (818) 578 4030

Contact: [www.mixware.net/help](http://www.mixware.net/help)

If you are located in Europe

Send the product to:

Sound Service GmbH European  
Headquarter Moriz-Seeler-Straße  
3D-12489 Berlin

Telephone: +49 (0)30 707 130-0

Fax: +49 (0)30 707 130-189

E-Mail: [info@sound-service.eu](mailto:info@sound-service.eu)

If you are located in Hong Kong

Send the product to:

ASIA OFFICE:

Unit F, 15/F., Fu Cheung Centre,

No. 5-7 Wong Chuk Yueng

Street, Fotan, Sha Tin, N.T., Hong Kong.

5. For additional update information please visit our website at:  
[www.iconproaudio.com](http://www.iconproaudio.com).





<p>天猫官方旗舰店</p>  <p>天猫店iconproaudio旗舰店</p>	<p>抖音号</p>  <p>抖音iCON艾肯</p>	<p>哔哩哔哩</p>  <p>B站iCONProAudio</p>	<p>微信公众号</p>  <p>微信号iCON-PRO</p>	<p>官方售后QQ</p>  <p>4006311312.114.qq.com</p>
--	--	---	---	--

中国地区用户

<p>Twitter</p>  <p><a href="http://www.twitter.com/iconproaudio">www.twitter.com/iconproaudio</a></p>	<p>Instagram</p>  <p><a href="http://www.instagram.com/iconproaudio">www.instagram.com/iconproaudio</a></p>	<p>Facebook</p>  <p><a href="http://www.facebook.com/iconproaudio">www.facebook.com/iconproaudio</a></p>	<p>Youtube</p>  <p><a href="http://www.youtube.com/iconproaudio">www.youtube.com/iconproaudio</a></p>
--	--	---	--

<p>Website</p>  <p><a href="http://www.iconproaudio.com">www.iconproaudio.com</a></p>	<p>Support</p>  <p><a href="http://support.iconproaudio.com">support.iconproaudio.com</a></p>	<p>Dashboard</p>  <p><a href="http://iconproaudio.com/dashboard/">iconproaudio.com/dashboard/</a></p>
---	---	---

[www.iconproaudio.com](http://www.iconproaudio.com)