

- NOTE(S):
 1. ALL DIMENSIONS SHOWN IN FORMAT:
 INCHES [MILLIMETERS]
 2. FWD-LACE-UMV-16-21 SHOWN
 3. REFER TO PAGE 4 OF THIS DOCUMENT FOR
 FITMENT MATRIX

REV	DESCRIPTION	REV BY	REV DATE	APP'D BY	DATE APP.
A	PRODUCTION RELEASE	///	////	NC	04/25/19

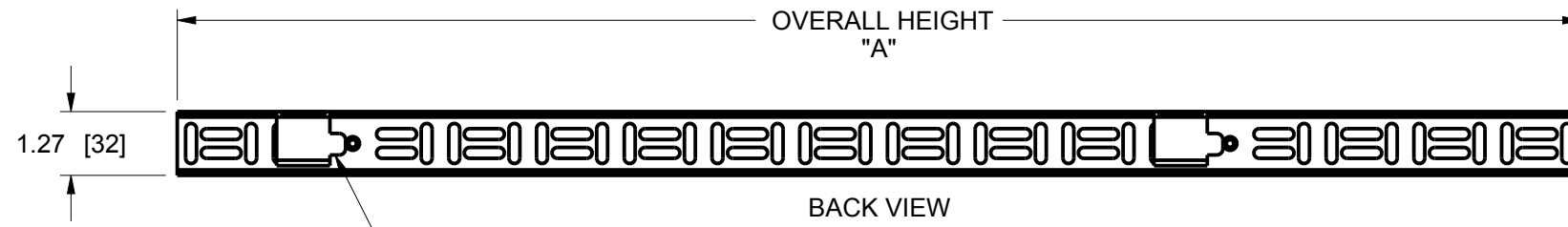

BGR MOUNTING BRACKET

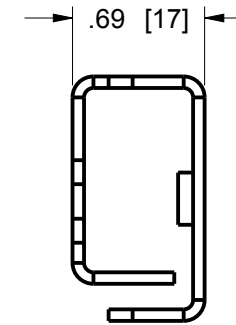
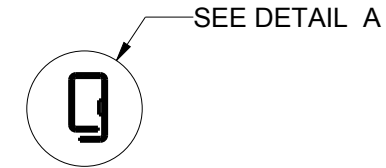
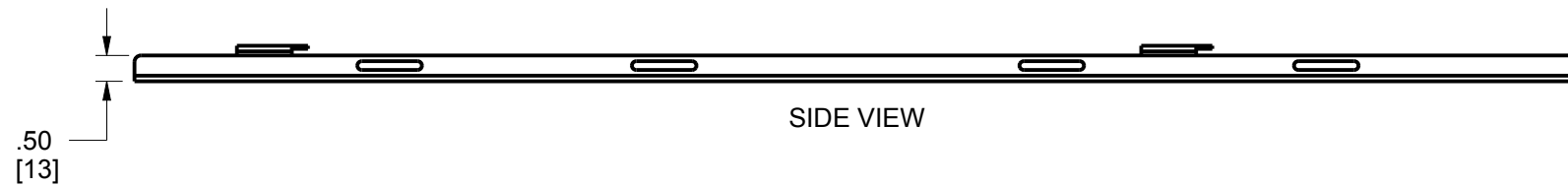

DETAIL A
SCALE 1/1

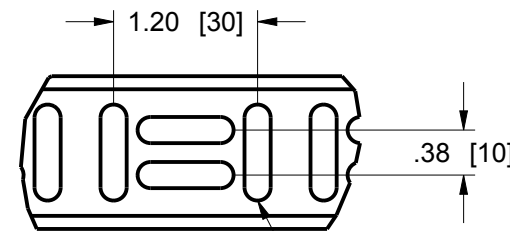

DETAIL B
SCALE 5/8

Ø .22 [6] X .80 [20] OBOUND
 FITS FORWARD QUICK MOUNT PLASTICS



MAP SKU#	"A" OVERALL HEIGHT	MOUNTING BRACKETS
FWD-LACE-UMV-44-45	78.75 [2000]	4
FWD-LACE-UMV-41-42	73.50 [1867]	4
FWD-LACE-UMV-35-40	61.25 [1556]	3
FWD-LACE-UMV-24-27	42.00 [1067]	2
FWD-LACE-UMV-16-21	28.00 [711]	2

PROJECTION: 1" ANGLE	UNLESS OTHERWISE SPECIFIED, ALL DIMENSIONS ARE IN INCHES
SCALE = 35/128	GENERAL TOLERANCES:
SHEET 1 OF 4	DEC: 1 PLACE +/-0.1 ANGLE: +/-1°
	2 PLACE +/-0.03 FRAC: +/-1/32
	3 PLACE +/-0.010
	HOLE SIZE: +/-0.002

APPROVALS	DATE
MODELED SB	01/28/19
DRAWN SB	04/23/19

Middle Atlantic Products, Inc.

TITLE FORWARD - VERTICAL LACE

DWG NO. 120-00004

DWG REV A

1 2 3 4 5 6 7 8

NOTE(S):
 1. ALL DIMENSIONS SHOWN IN FORMAT:
 INCHES [MILLIMETERS]
 2. FWD-LACE-WB3-16-21 SHOWN
 3. REFER TO PAGE 4 OF THIS DOCUMENT FOR
 FITMENT MATRIX

A

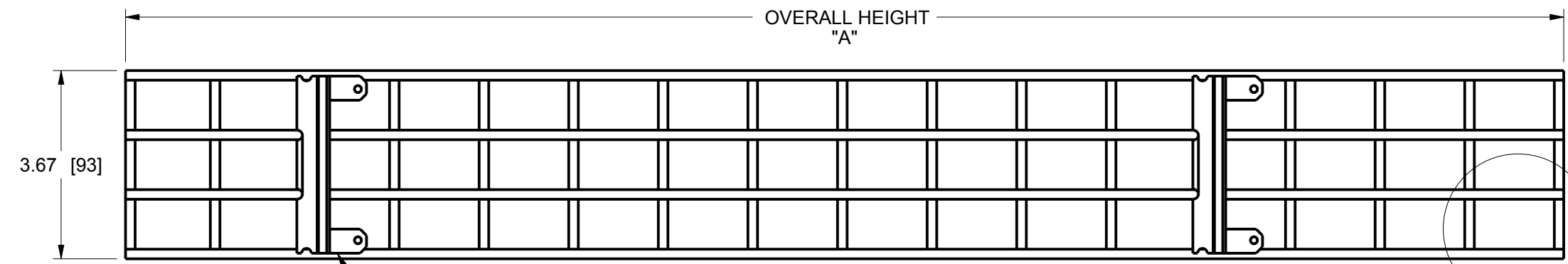

BGR MOUNTING BRACKET

BACK VIEW

SEE DETAIL D

B

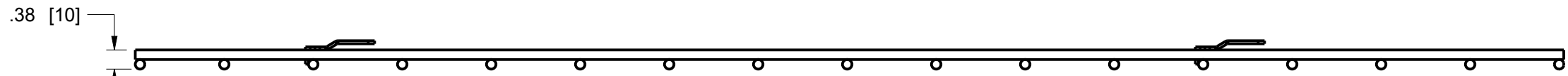

SIDE VIEW

C

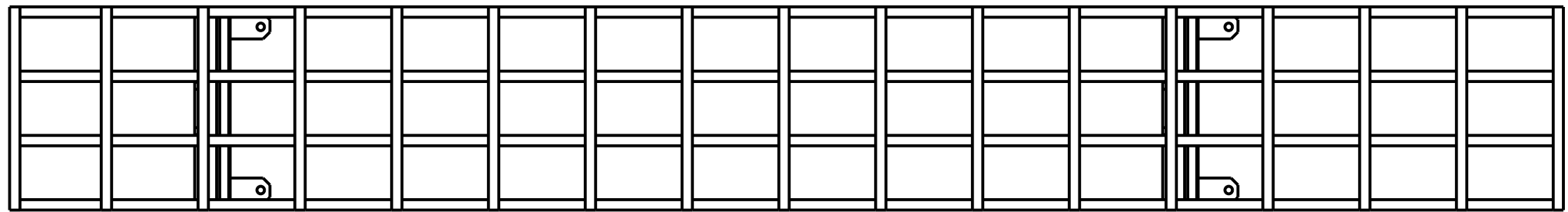

FRONT VIEW

D

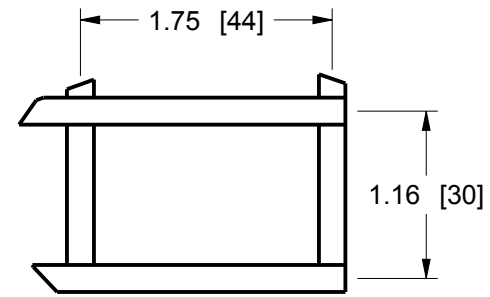

DETAIL D
SCALE 3/4

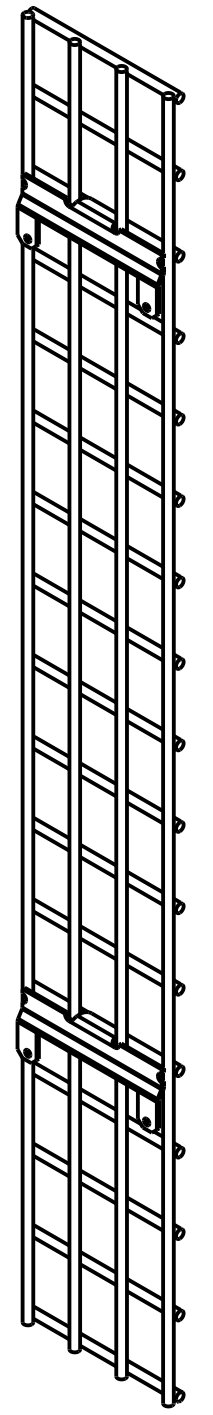

SCALE 19/64

E

MAP SKU#	"A" OVERALL HEIGHT	MOUNTING BRACKETS
FWD-LACE-WB3-44-45	78.84 [2003]	4
FWD-LACE-WB3-41-42	73.59 [1869]	4
FWD-LACE-WB3-35-40	61.34 [1558]	3
FWD-LACE-WB3-24-27	42.09 [1069]	2
FWD-LACE-WB3-16-21	28.09 [713]	2

PROJECTION: 1" ANGLE SCALE = 3/64 SIZE B SHEET 2 OF 4	UNLESS OTHERWISE SPECIFIED, ALL DIMENSIONS ARE IN INCHES GENERAL TOLERANCES: DEC: 1 PLACE +/-0.1 ANGLE: +/-1° 2 PLACE +/-0.03 FRAC: +/-1/32 3 PLACE +/-0.010 HOLE SIZE: +/-0.002	APPROVALS	DATE		TITLE	FORWARD - VERTICAL LACE
		MODELED SB DRAWN SB	01/29/19 04/23/19		DWG NO.	120-00004

THIS DRAWING CONTAINS TRADE INFORMATION DEEMED TO BE CONFIDENTIAL AND PROPRIETARY PROPERTY OF MIDDLE ATLANTIC PRODUCTS, INC. AND IS TO BE USED ONLY FOR THE PURPOSES FOR WHICH IT IS SUBMITTED AND FURTHER SHALL NOT BE COPIED IN WHOLE OR PART WITHOUT WRITTEN PERMISSION FIRST OBTAINED FROM MIDDLE ATLANTIC PRODUCTS, INC.

1 2 3 4 5 6 7 8

NOTE(S):
 1. ALL DIMENSIONS SHOWN IN FORMAT:
 INCHES [MILLIMETERS]
 2. FWD-UVPB-42-45 SHOWN
 3. FOR BUTTON STYLE MOUNTING POWER STRIPS
 4. FITS THE FOLLOWING RACKS:
 - BGR-45XX
 - MRK-44XX
 - VRK-44-XXH
 - WRK-44-XX

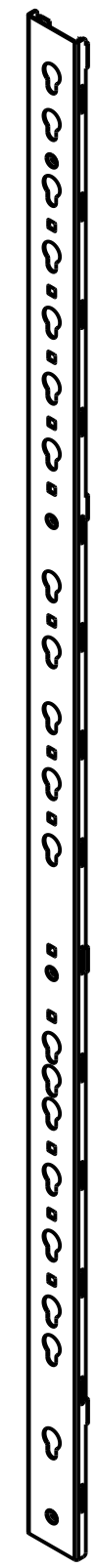
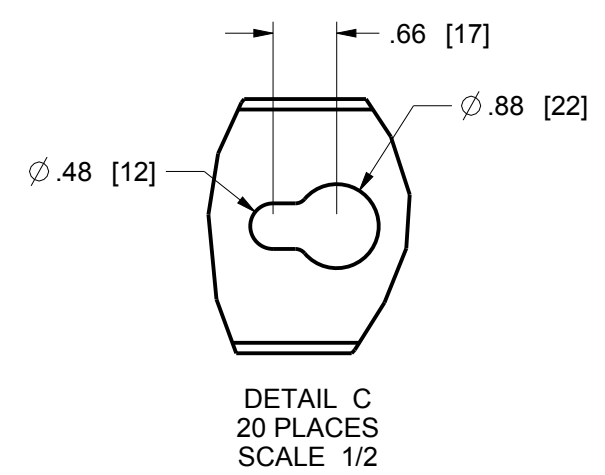
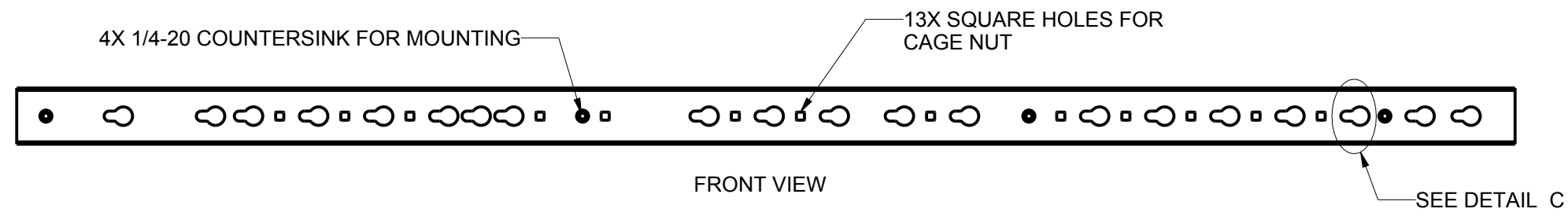
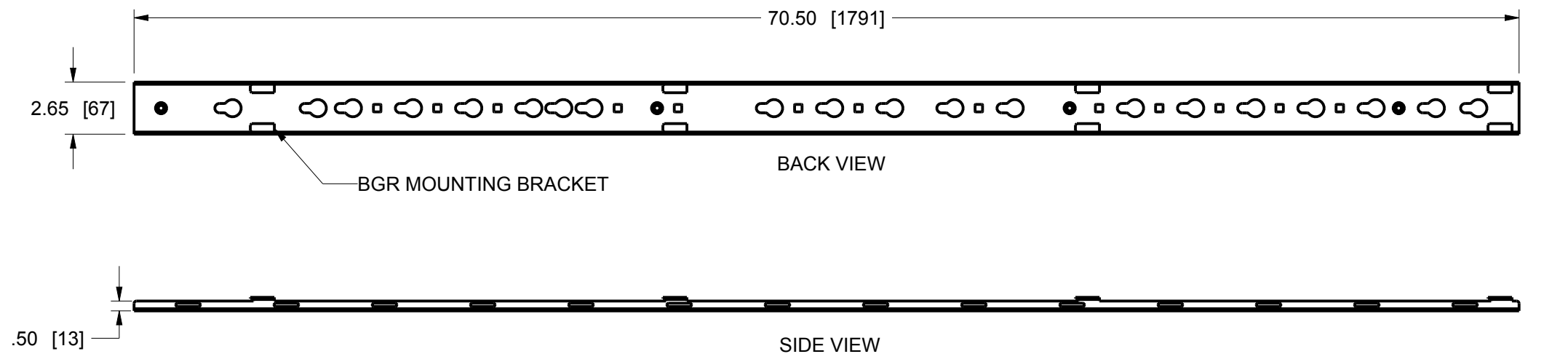

PROJECTION: 1" ANGLE 	UNLESS OTHERWISE SPECIFIED, ALL DIMENSIONS ARE IN INCHES GENERAL TOLERANCES: DEC: 1 PLACE +/-0.1 ANGLE: +/-1° 2 PLACE +/-0.03 FRAC: +/-1/32 3 PLACE +/-0.010 HOLE SIZE: +/-0.002	APPROVALS	DATE		TITLE	FORWARD - VERTICAL LACE
		MODELED SB DRAWN SB	01/28/19 04/23/19		DWG NO.	120-00004
SIZE B SHEET 3 OF 4						

THIS DRAWING CONTAINS TRADE INFORMATION DEEMED TO BE CONFIDENTIAL AND PROPRIETARY PROPERTY OF MIDDLE ATLANTIC PRODUCTS, INC. AND IS TO BE USED ONLY FOR THE PURPOSES FOR WHICH IT IS SUBMITTED AND FURTHER SHALL NOT BE COPIED IN WHOLE OR PART WITHOUT WRITTEN PERMISSION FIRST OBTAINED FROM MIDDLE ATLANTIC PRODUCTS, INC.

A

B

C

D

E

SKU #	FWD-LACE-WB3-16-21 FWD-LACE-UMV-16-21	FWD-LACE-WB3-24-27 FWD-LACE-UMV-24-27	FWD-LACE-WB3-35-40 FWD-LACE-UMV-35-40	FWD-LACE-WB3-41-42 FWD-LACE-UMV-41-42	FWD-LACE-WB3-44-45 FWD-LACE-UMV-44-45
BGR					
BGR-19XX	X				
BGR-25XX		X			
BGR-38XX		X	X		
BGR-41XX	X			X	
BGR-45XX		X			X
DWR					
DWR-10-XX					
DWR-12-XX					
DWR-16-XX	X				
DWR-18-XX	X				
DWR-21-XX	X				
DWR-24-XX		X			
DWR-35-XX	X	X	X		
ERK					
ERK-18XX	X				
ERK-21XX	X				
ERK-27XX		X			
ERK-35XX	X	X	X		
ERK-40XX	X	X	X		
ERK-44XX	X	X	X	X	X
MRK					
MRK-24XX	X	X			
MRK-37XX	X	X	X		
MRK-40XX	X	X	X	X	
MRK-44XX	X	X	X	X	X
SNE					
SNE - 24 SP		X			
SNE - 42 SP		X	X	X	
SNE - 45 SP		X	X	X	X
SR					
SR-24-XX		X			
SR-40-XX	X	X	X		
SR-46-XX	X	X	X	X	X
VRK					
VRK-44-XXH	X	X	X	X	X
WRK					
WRK-24-XX		X			
WRK-37-XX	X	X	X		
WRK-40-XX	X	X	X		
WRK-44-XX	X	X	X		X

FITMENT MATRIX

PROJECTION: 1" ANGLE

 SCALE = 21/128
 SIZE B SHEET 4 OF 4

UNLESS OTHERWISE SPECIFIED, ALL DIMENSIONS ARE IN INCHES
 GENERAL TOLERANCES:
 DEC: 1 PLACE +/-0.1 ANGLE: +/-1°
 2 PLACE +/-0.03 FRAC: +/-1/32
 3 PLACE +/-0.010
 HOLE SIZE: +/-0.002

APPROVALS	DATE
MODELED SB	03/29/19
DRAWN SB	04/23/19



TITLE	FORWARD - VERTICAL LACE	
DWG NO.	120-00004	DWG REV A