

QS Sensor Module

Installation Instructions *Please Read Before Installing*

English

QSM — QS Sensor Module

QSM2-4W-C	24 V \approx 400 mA	434 MHz, wired and wireless input
QSM2-4W-J	24 V \approx 400 mA	434 MHz, wired and wireless input, junction box mount
QSM2-XW-C	24 V \approx 100 mA	434 MHz, wireless input only
QSM2-XW-J	24 V \approx 100 mA	434 MHz, wireless input only, junction box mount
QSM3-4W-C	24 V \approx 400 mA	868 MHz, CE, wired and wireless input
QSM3-4W-J	24 V \approx 400 mA	868 MHz, CE, wired and wireless input, junction box mount
QSM4-4W-C	24 V \approx 400 mA	868 MHz, CE, Singapore and China, wired and wireless input
QSM4-4W-J	24 V \approx 400 mA	868 MHz, CE, Singapore and China, wired and wireless input, junction box mount
QSM5-XW-C	24 V \approx 100 mA	865 MHz, wireless input only
QSM6-XW-C	24 V \approx 100 mA	315 MHz, Japan, wireless input only
QSM7-4W-C	24 V \approx 400 mA	434 MHz, Hong Kong, wired and wireless input
QSM7-XW-C	24 V \approx 100 mA	434 MHz, Hong Kong, wireless input only
QSMX-4W-C	24 V \approx 400 mA	Non-RF, wired input only

Compatible Products

- Lutron ® Wired Sensors
 - Occupancy - LOS-series
 - EcoSystem ® Infrared (IR) - EC-IR-
- EcoSystem ® IR Wallstations
- Lutron ® Radio Powr Savr ™ Sensors
 - Occupancy/Vacancy
 - Daylight
- Lutron ® Pico ® Wireless Controllers
 - Quantum ™
 - GRAFIK Eye ® QS
 - Energi Savr Node ™

Product Description

Lutron's QS Sensor Module (QSM) allows integration of input devices (wired and/or wireless) such as Lutron ® occupancy sensors, daylight sensors, IR sensors and Pico ® Wireless Controllers to a compatible load control. For devices that already integrate directly with sensor inputs, the QSM can expand the number of available inputs or expand the wireless coverage.

Easy-to-follow Instructions



P/N 041-336a

Important Notes

- QSM is part of a system and cannot be used to control a load without a compatible system device. Refer to the www.lutron.com and the instruction sheets of the system device(s) for installation information.
 - Clean QSM with a soft damp cloth only. DO NOT use any chemical cleaners.
 - QSM is intended for indoor use only. Operate between 32 °F and 104 °F (0 °C and 40 °C).
 - DO NOT paint QSM.
 - The range and performance of the wireless system is highly dependent on a variety of complex factors such as:
 - Distance between system components
 - Geometry of the building structure
 - Construction of walls separating system components
 - Electrical equipment located near system components
- QSM wireless range:
- 60 ft (18 m) line of sight
 - 30 ft (9 m) through walls
- Metal objects block wireless communication. Avoid installing QSM on or within metal surroundings other than junction box.

Included Components

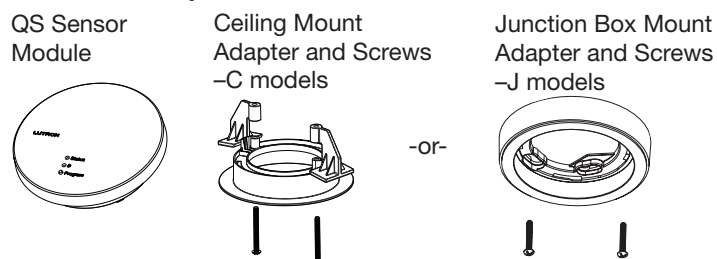

Tools You May Need

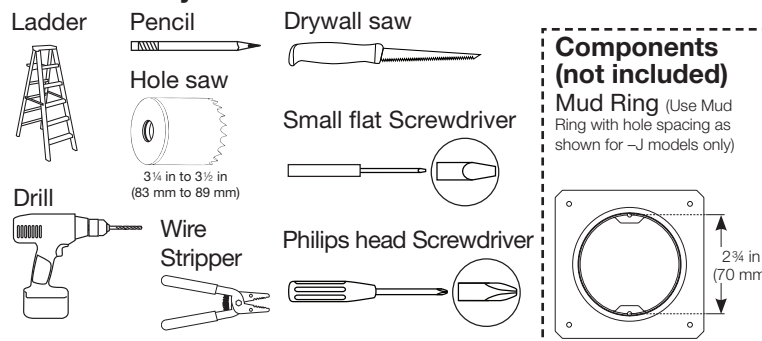

Technical Assistance

For questions concerning the installation or operation of this product, call the **Lutron Technical Support Center**. Please provide exact model number when calling.

U.S.A. and Canada (24 hrs / 7days)
1.800.523.9466

Mexico 8am – 8pm ET
+1.888.235.2910

India, New Delhi Lutron GL Sales and Services
+91 124 471 1900

Singapore
+65.6220.4666

China, Shanghai (Pudong)
+86.21.5153.3600

www.lutron.com

Other countries 8am – 8pm ET
+1.610.282.3800

United Kingdom
0800.282.107

Europe
+44.(0)20.7680.4481

Hong Kong
+852.2104.7733

Japan
+81.3.5575.8411

FCC Information

NOTE: This equipment has been tested and found to comply with the limits for a Class B digital device, pursuant to part 15 of the FCC rules. These limits are designed to provide reasonable protection against harmful interference in a residential installation. This equipment generates, uses and can radiate radio frequency energy and, if not installed and used in accordance with the instructions, may cause harmful interference to radio and television reception, which can be determined by turning the equipment off and on. The user is encouraged to try to correct the interference by one or more of the following measures:

- Reorient or relocate the receiving antenna.
- Increase the separation between the equipment and receiver.
- Connect the equipment into an outlet on a circuit different from that to which the receiver is connected.
- Consult the dealer or an experienced radio/TV technician for help.

Caution: Changes or modifications not expressly approved by Lutron Electronics Co. could void the user's authority to operate this equipment.

This device complies with Part 15 of the FCC rules. Operation is subject to the following two conditions:

- This device may not cause harmful interference, and
- This device must accept any interference received, including interference that may cause undesired operation.

Lutron Electronics hereby declares that QSM3-4W and QSM3-XW are in compliance with the essential requirements and other relevant provisions of Directive 1999/5/EC. A copy of the DoC can be obtained by writing to: Lutron Electronics Co., Inc. 7200 Suter Road, Coopersburg, PA 18036 U.S.A.

Limited Warranty

(Valid only in U.S.A., Canada, Puerto Rico, and the Caribbean.)

Lutron will, at its option, repair or replace any unit that is defective in materials or manufacture within one year after purchase. For warranty service, return unit to place of purchase or mail to Lutron at 7200 Suter Rd., Coopersburg, PA 18036-1299, postage pre-paid. **THIS WARRANTY IS IN LIEU OF ALL OTHER EXPRESS WARRANTIES, AND THE IMPLIED WARRANTY OF MERCHANTABILITY IS LIMITED TO ONE YEAR FROM PURCHASE. THIS WARRANTY DOES NOT COVER THE COST OF INSTALLATION, REMOVAL OR REINSTALLATION, OR DAMAGE RESULTING FROM MISUSE, ABUSE, OR DAMAGE FROM IMPROPER WIRING OR INSTALLATION. THIS WARRANTY DOES NOT COVER INCIDENTAL OR CONSEQUENTIAL DAMAGES. LUTRON'S LIABILITY ON ANY CLAIM FOR DAMAGES ARISING OUT OF OR IN CONNECTION WITH THE MANUFACTURE, SALE, INSTALLATION, DELIVERY, OR USE OF THE UNIT SHALL NEVER EXCEED THE PURCHASE PRICE OF THE UNIT.**

This warranty gives you specific legal rights, and you may have other rights which vary from state to state. Some states do not allow the exclusion or limitation of incidental or consequential damages, or limitation on how long an implied warranty may last, so the above limitations may not apply to you.

Lutron, EcoSystem, Pico, Quantum, and GRAFIK Eye are registered trademarks and Radio Powr Savr, Energi Savr Node, and ClearConnect are trademarks of Lutron Electronics Co., Inc.

© 2011 Lutron Electronics Co., Inc.

LUTRON

Lutron Electronics Co., Inc.
7200 Suter Road, Coopersburg, PA 18036-1299, U.S.A.
P/N 041-336 Rev. A 06/2011

Instructions

Getting Started

Key Features

- Easy Installation.** QSM can be mounted on a variety of ceiling materials (thickness ranging from 1/4 in to 1 1/4 in [6 mm to 32 mm]) with the adapter provided.
- Easy Set-up.** QSM has auto-detection capabilities on the wired sensor inputs. After the inputs are properly wired, the QSM will recognize the input (device) type after a valid signal is received. For example: occupied room, IR signal, etc.
- ClearConnect ™ Technology.** Up to 30 wireless devices, comprised of up to 10 Radio Powr Savr ™ daylight sensors, 10 Radio Powr Savr ™ occupancy sensors, and 10 Pico ® Wireless Controllers can be associated with QSM.

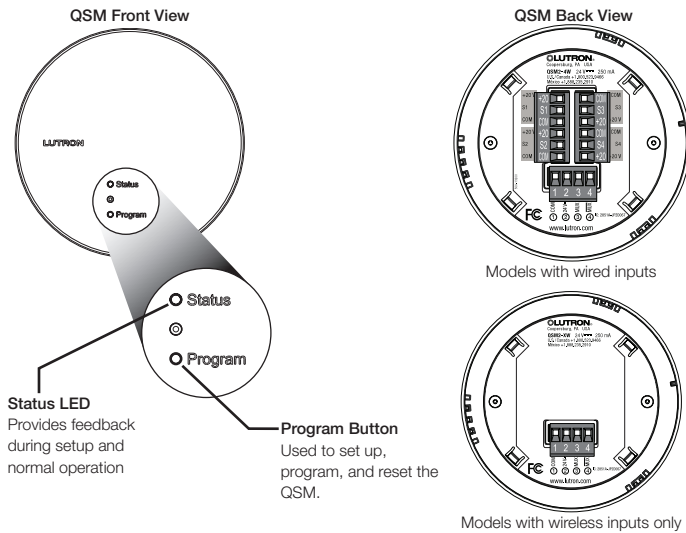

QSM Operation

- Wired devices:** Wired Occupancy sensors, EcoSystem ® daylight sensors, EcoSystem ® IR sensors, and EcoSystem ® IR wallstations can be wired directly to the QSM.
- Wireless devices:** Wireless Radio Powr Savr ™ occupancy sensors, Radio Powr Savr ™ daylight sensors and Pico ® Wireless Controllers can be associated to the QSM.
- Power:** QSM is powered from the QS link.

Refer to the table below and source power draw unit output to ensure enough power is available to power your system.

QSM Configuration	Power Draw Units (PDU)
QSM	3
Wireless Input Devices	0
1 Wired Occupancy Sensor	2
1 Wired Daylight Sensor	0.5
1 Wired IR (Infrared) Sensor	0.5
1 Wired IR Wallstation	0.5

Installation

The QSM installation procedure is outlined below. Please follow these steps to ensure that the QSM will perform as intended.

1 Choose a Location to Install

All wireless devices to be associated to the QSM must be within the specified range listed below. In addition, 4 wired inputs can be connected to the same QSM. Refer to the Wiring section for details.

- QSM wireless range:
- 60 ft (18 m) line of sight
 - 30 ft (9 m) through walls

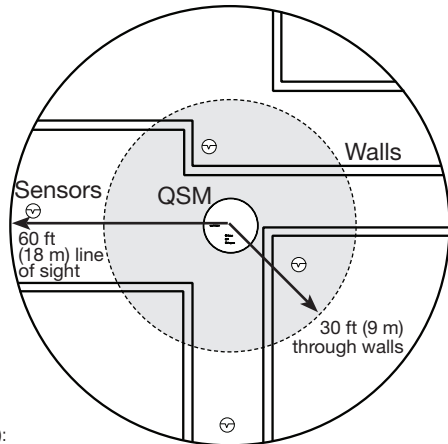

- Wired sensors: up to 4.
- Wireless devices (up to 30 total):
 - Max. 10 Radio Powr Savr ™ occupancy sensors
 - Max. 10 Radio Powr Savr ™ daylight sensors
 - Max. 10 Pico ® Wireless Controllers

2 Installing the Ceiling Mount Adapter

Cut a 3/4 in to 3/2 in (83 mm to 89 mm) diameter mounting hole to insert the mud ring.

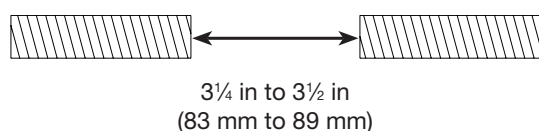

3 Insert Mud Ring or Ceiling mount adapter

Insert the ceiling mount adapter into the hole and rotate brackets outwards by turning screws. -C models

Insert the Mud Ring with Junction Box as shown below. Do not allow the ceiling tile to bear the weight of junction box. -J models

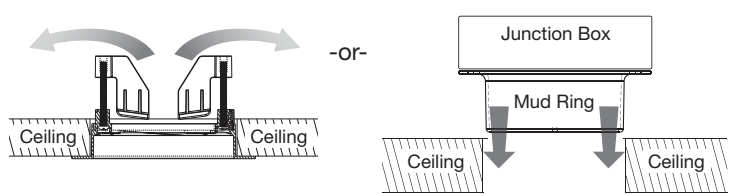

4 Clamp adapter to ceiling

Using a Phillips screwdriver, hand-tighten the brackets, clamping the adapter to the ceiling. Do not overtighten. -C models

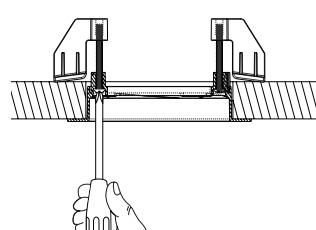

Using a Phillips screwdriver, hand-tighten the brackets, clamping the adapter to the mud ring. Do not overtighten. -J models

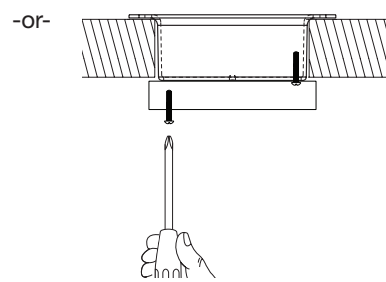

5 Run wires

For each wired input that will be connected to the QSM, run wiring for QS link and pull through the ceiling mount adapter hole. Leave enough wire to connect to QSM.

Note: Refer to table for appropriate wiring information. Strip wire to 3/8 in (9 mm)

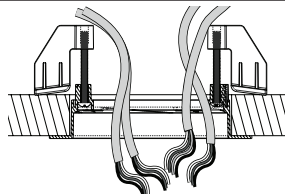

QS Link	Wire Gauge	Available from Lutron in one cable
		GRX-CBL-346S or GRX-PCBL 346S
Less than 500 ft (153 m)	Power (terminals 1 and 2): 1 pair 18 AWG (1.0 mm 2)	GRX-CBL-46L or GRX-PCBL-46L
	Data (terminals 3 and 4): 1 pair 22 AWG (0.5 mm 2), twisted and shielded*	
500 ft (153 m) to 2000 ft (610 m)	Power (terminals 1 and 2): 1 pair 12 AWG (4.0 mm 2)	C-CBL-S222S-WH-1 or C-PCBL-S222S-CL-1
	Data (terminals 3 and 4): 1 pair 22 AWG (0.5 mm 2), twisted and shielded*	
Wired Inputs	Max. wire length	150 ft (46 m)
	Max. wire gauge	16 AWG (1.5 mm 2)
	Min. wire gauge	22 AWG (0.5 mm 2)

*Alternate data-only cable: Use approved data link cable (22 AWG (0.5 mm 2) twisted, shielded) from Belden, model #9461.

Connect wiring

Connect wiring for QS link and wired sensors (if applicable) to the appropriate terminals on the QSM.

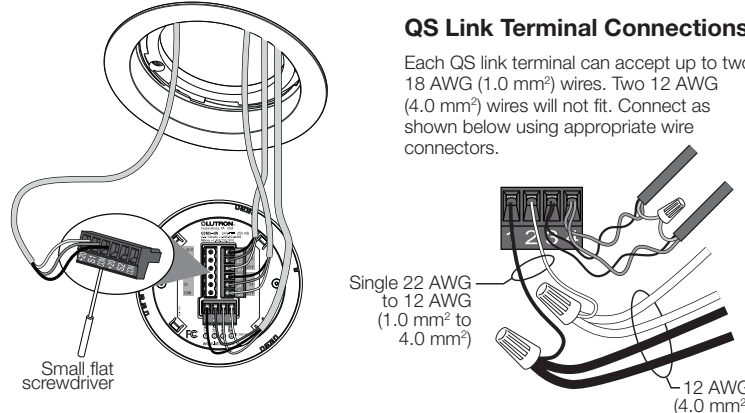

QS Link Terminal Connections

Each QS link terminal can accept up to two 18 AWG (1.0 mm 2) wires. Two 12 AWG (4.0 mm 2) wires will not fit. Connect as shown below using appropriate wire connectors.

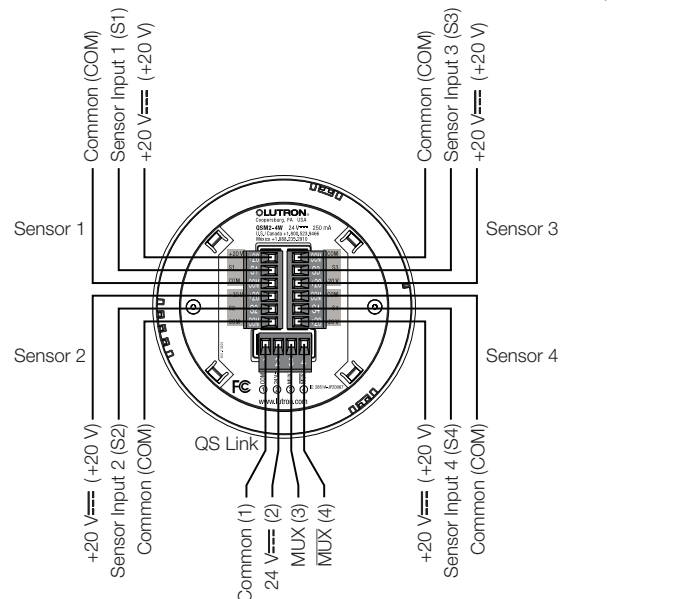

Troubleshooting

Symptom	Possible Causes	Solution
Unit does not power wired sensors.	Miswire.	Check wiring. Refer to section 5, Run Wires.
Lights don't turn on when supposed to.	Power source not connected or is turned off.	Check connection or source of power.
Status LED on front of QSM is not on.	System short circuit.	Find and correct shorts.
	Current budget of the power-sourcing device has been exceeded.	Make sure QSM is not overloaded and only 1 wired sensor is connected to each sensor input.
Front enclosure is warm.	Normal operation.	Depending on the wired sensor load, current draw of QSM may exceed the limits of the power sourcing device (refer to power source device instructions for power draw budget). In such a case, use QSPS to power QSM. QSM circuit dissipates a small amount of power. No action is required.
Cannot associate a wireless device to the QSM.	Wireless device is not compatible with QSM.	Radio Powr Savr ™ occupancy sensor, Radio Powr Savr ™ daylight sensor and Pico ® Wireless Controller are the only wireless devices that can be associated to QSM.
	QSM is not in sensor association mode.	Make sure QSM is in sensor association mode. Refer to section 7, Set-up.
	Maximum number of wireless devices has been reached.	If you are getting a 5-second long beep after sensor association attempt, this means you've already reached the limiting number in that particular type of wireless input. Additional QSMs may be needed to accommodate all input devices.
	Wireless device is out of range.	Verify wireless device is within range (30 ft [9 m] through walls, 60 ft [18 m] line of sight). For more info on wireless range, refer to section 1, Choose a Location to Install.
Auto-detection of wired sensors does not work.	Miswire.	Check wiring. Check if sensors receive power from QSM. Refer to section 5, Run Wires.
	Sensor inputs swapped after detection has occurred.	Once the wired sensors are detected, they are assigned to their sensor ports. Swapping the sensors after auto-detection will cause malfunction. QSM will re-detect new locations (if wired inputs are reset). Refer to section 7A, Wired Input Devices for reset instructions. System logic and functionality must be updated with new detected configuration.
	QSM has not received a valid signal from input device.	Under normal circumstances, auto-detection may take a few minutes depending on room conditions. To facilitate this, user can shine a flashlight at daylight sensors, trigger occupancy sensors and send valid IR signals to IR sensors. QSM must receive a valid signal to detect the input device.
Associated wireless devices do not control assigned lights/wireless devices operate incorrectly.	Wireless device has been unassigned from QSM.	Re-assign wireless device to QSM.
	Devices are not receiving power.	Check wireless device's battery.
	Out of wireless range.	Verify wireless device is within range (30 ft [9 m] through walls, 60 ft [18 m] line of sight). For more info on wireless range, refer to section 1, Choose a Location to Install.
	System is not configured correctly or wireless devices are not properly located.	Make sure the logic for QSM sensors and inputs has been programmed on other system devices (i.e. Energi Savr Node ™ , GRAFIK Eye ® QS, etc.).
Wireless occupancy sensors have different user interfaces	Normal	Successive Radio Powr Savr Occupancy models have a different user interface. All types associate using the lights off or button

6 Attach QSM to Adapter

Attach the QSM into the ceiling mount adapter by inserting and twisting in a clockwise direction until the sensor locks into place.

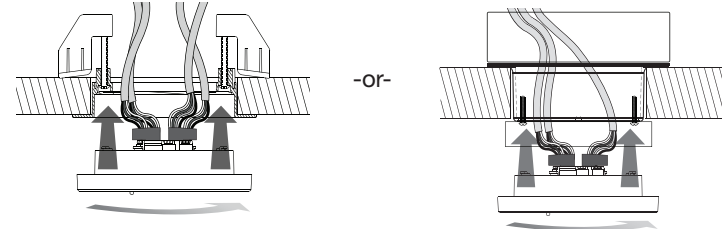

7 Set-up

A. Wired Input Devices (if available)

There are 4 types of wired input devices that can be connected to a QSM; Lutron ® occupancy sensors, Lutron ® EcoSystem ® daylight sensors, Lutron ® EcoSystem ® IR sensors and Lutron ® EcoSystem ® wallstations.

- Once these inputs are connected to a QSM, upon power up, the QSM will automatically detect and configure the wired inputs after a valid signal is received (i.e. occupied room, IR signal, etc.).
- If inputs are ever removed and rewired into different ports, the QSM will need to be reset so the new configuration can be detected.
- To reset and redetect wired inputs press and hold "Program" button for 10 seconds. Note: First, there will be a long beep after 3 seconds. Continue to hold until the second long beep after 10 seconds. QSM will power up and new configuration of wired input devices will be detected after valid signals are received. Note: Load control logic may need to be reconfigured.
- Refer to instructions of connected device to setup input function and logic.

B. Wireless Input Devices (if available)

Wireless input devices must be associated to only one QSM before they are assigned to control system devices.

- Press and hold "Program" button on the QSM for 3 seconds to enter Sensor Association Mode. You will hear a 1-second beep upon entering. LED will blink twice every second in the sensor association mode.
- For each wireless device you wish to associate, press and hold the appropriate button on the device according to the following table.

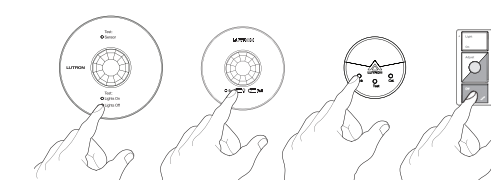

Input Device	Button	Duration
Radio Powr Savr ™ Occupancy Sensor	Lights Off/	6 seconds
Radio Powr Savr ™ Daylight Sensor	Link	6 seconds
Pico ® Wireless Controller	Off	6 seconds

After each successful input association, QSM will respond with 3 long beeps.

If maximum number of associations to QSM has been exceeded for a wireless input device type, QSM will respond with a long 5 second beep.

- For a given QSM Link if input device has already been associated to another QSM, the QSM to which you are attempting to associate will respond with 10 short beeps to warn that the input device is already associated to a different QSM.
- If you choose to ignore the warning and try to associate the same input device to the QSM a second time, the input device will be removed from association with the previous QSM and will now be associated with the new QSM.
- Press and hold "Program" button on QSM for 3 seconds to exit Sensor Association Mode. Note: QSM will time-out and exit Sensor Association Mode after 10 minutes of inactivity.

8 Program System Logic

QSM is part of a system and cannot be used to control a load without a compatible system device with correct settings. After wired and wireless inputs are associated with QSM, you must program the system logic and functionality using a compatible system load control component (Energi Savr Node ™ , Quantum ™ , GRAFIK Eye ® QS, etc.).